

Binding Post - Insulated Standard

SPECIFICATIONS

Stud: Brass per QQ-B-626D

Finish: Silver

Insulating Material: Nylon 6/6 per ASTM D4066

Hardware: Nickel plated nut (unassembled)

Body Thread Stripping Torque: 6.0 lb. in. (7.0 kg cm)

Panel Thickness: Up to .281 (7.15)

RATINGS

Current: 15 amps

Contact Resistance: 0.010 ohms maximum

Breakdown Voltage: 5700 Vrms minimum

Stud-to-Panel: 3.3 pF nominal

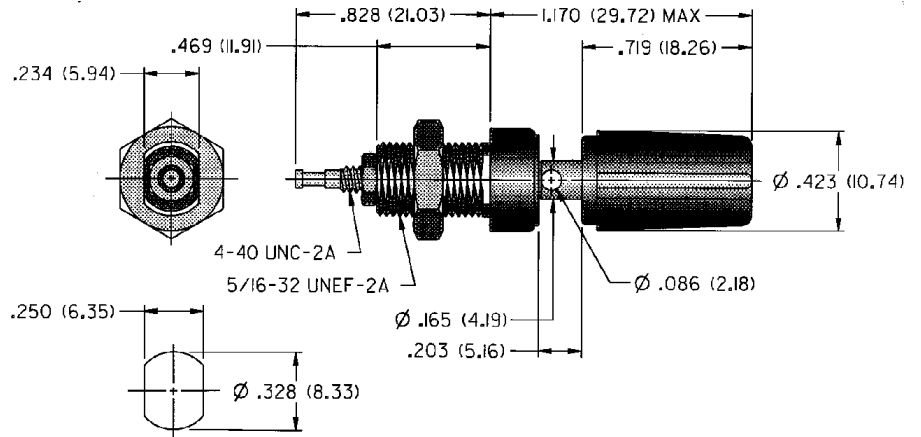

MOUNTING HOLE LAYOUT

SILVER PLATING	
11-0102-001	Red

For Standard Banana Plug: .175 (4.44) Dia.

FEATURES:

- Turret terminal
- Captive thumb nut
- Insulated body is flatted to prevent turning
- Nylon UL approved for self-extinguishing