

Overview .....	T-2
1.00mm (.040") Pitch System – 040 III .....	T-3 to T-5
1.00/2.30mm (.040/.090") Pitch System – 0409 Hybrid Housings .....	T-6 to T-7
Stac64™ .....	T-8 to T-13
H-DAC 64™ .....	T-14 to T-15
MOX System .....	T-16 to T-18
MOST System .....	T-18 to T-20
NSCC System .....	T-21 to T-22, T-49 to T-50
OBD-II Connectors .....	T-22 to T-23
MX150™ Sealed Connector System .....	T-24 to T-28
2.50mm (.098") Pitch Wire-to-Wire Splash Proof Connectors	
Terminals .....	T-29, T-32
Receptacles .....	T-30
Plugs .....	T-31
Receptacle Housing and Plug Housing .....	T-33
MX123™ Sealed Connector System .....	T-34 to T-36
MX64™ Sealed Connector System .....	T-37
CMC System .....	T-38 to T-47
CMC CP System .....	T-48 to T-49
Bulb Sockets	
Terminals .....	T-51
Sealed Sockets .....	T-52
HSAutoLink™ Cable Assemblies .....	T-53 to T-56

Visit [www.molex.com](http://www.molex.com) to access more part numbers and product information, download sales drawings, product specifications, 3D models, place sample requests, and more.

As a major supplier to the global automotive industry, Molex offers vehicle manufacturers and their suppliers a wide range of products and extensive research and development capabilities that include rapid prototyping and high volume production support. In addition, we apply breakthrough technologies from other markets and industries and apply them to in-vehicle electronic devices.

The average new vehicle today contains twice as many connectors as models produced only ten years ago. As electronic content increases in automotive vehicles, Molex is responding with solutions that simplify electrical distribution systems. We are dedicated to reducing weight and packaging space while boosting performance and reliability. Many products incorporate our proprietary technologies in shielding, filtering and assembly.

Our automotive design teams are located in technical centers throughout the world and are linked electronically to share expertise and expedite development. All of our manufacturing sites are ISO 9000 and QS 9000 certified and we currently support automotive manufacturing in all areas of the world.

We are dedicated to developing products that address the growing demand for innovative electrical interfaces, and Molex has created and defined new industry standards by partnering with many agencies including USCAR.

Molex has created unique connector interfaces for four key application segments:

**Power train**

- Fully sealed, high performance interconnect systems that offer the densest package in the automotive market
- MX123™ and CMC accommodate low level signal and high current load requirements
- Mate assist receptacles reduce harness assembly complexity by integrating the housing, lever, terminal retention feature and connector retention features in one standard assembly
- Sealing performance and package size are optimized by utilizing interfacial and matte seal technologies
- Applications include: on-engine, off road construction, industrial equipment

**Sealed**

- Wide standard product portfolio dedicated to offering low and stable contact resistance in harsh applications
- Available in matte sealed and cable sealed versions, the MX150™ systems are designed to support current loading for both low-level signal and power applications up to 22.0A
- The MX150 connector footprint and profile has been adapted by industry agency USCAR as their design criteria for systems supporting this specification
- Applications include: exterior lighting, door lock mechanisms, fuel injectors, spark plugs, wiper motors, washers, power steering and hosts of other safety devices

**Unsealed**

- Stack64™, the modular 0.64mm, 1.50mm and 2.80mm terminal interconnect system, addresses the growing electronic device requirements within today's vehicles by supporting both low-level signal requirements and power requirements up to 30.0A
- Fully-validated to USCAR specifications, Stack64 header assemblies can be used as stand alone components or multiple headers may be ganged together to support a large range of signal and power needs without the need for additional tooling
- Other product in this application segment include: H-DAC64™, MOST, MOX, NSCC
- Applications include: radios, amplifiers, power seats, HVAC, door zone modules, interior lighting, electronic mirrors and most interior electronic interfaces

**High Speed**

- Molex's HSAutoLink™ family is the emerging high-speed data bus for vehicles, encompassing technologies such as Universal Serial Bus (USB 2.0), Low Voltage Differential Signaling (LVDS), 1394, FlexRay, eMOST and Ethernet
- Leveraging data communications expertise, Molex has packaged an economical and widely deployed five-pin shielded connection system from the consumer market into a more rugged connector system to meet automakers' mechanical requirements and to bring USB and other technologies to vehicle information and entertainment systems
- USCAR-30 supports USB 2.0 requirements for OEM system certification
- Applications include: MP3 players, infotainment, telematic devices, safety cameras and displays



MX123™



CMC



MX150™

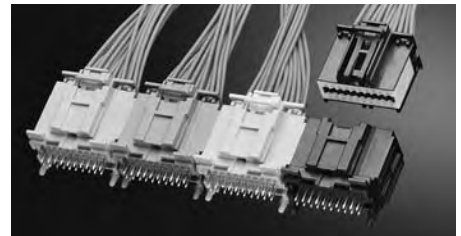

Stack64™



HSAutoLink™

# 1.00mm (.040") Tab Terminal

**50654**  
**Female**

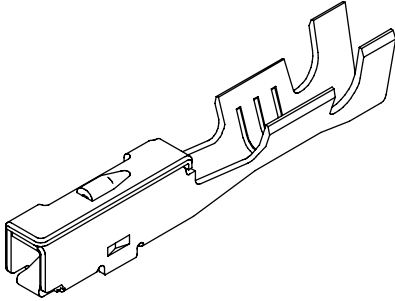

Order No.	Wire Range (mm <sup>2</sup> )	Lead-free
<a href="#">50654-1001</a>	AVS (AVSS) 0.3-0.5	Yes

### Features and Benefits

- Locking tab secures terminal to housing

### Reference Information

Product Specification: PS-68145-002

Packaging: Reel

Mates With: 50660 Terminal

Use With: 35563, 35564, 35896, 35898, 49014, 64002 and 68508 housings

Designed In: Millimeters

### Electrical

Voltage: 13V

Current: 5.0A max.

Contact Resistance: 5 milliohms max.

Dielectric Withstanding Voltage: 1000V AC

Insulation Resistance: 500V DC Megohms min.

### Mechanical

Contact Insertion Force: 1.5 kgf max.

Contact Retention to Housing: 8.0 kgf min.

Durability: 50 cycles

### Physical

Contact: Copper Alloy

Plating: Pre-Tin

[www.molex.com/customer.html?seriesNumber=50654](http://www.molex.com/customer.html?seriesNumber=50654)

# 1.00mm (.040") Tab Terminal

**50660**  
**Male**

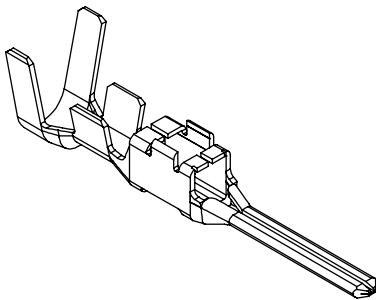

Order No.	Wire Range (mm <sup>2</sup> )	Lead-free
<a href="#">50660-9001</a>	AVS (AVSS) 0.3-0.5	Yes

### Features and Benefits

- Locking tab secures terminal to housing

### Reference Information

Product Specification: PS-68145-002

Packaging: Reel

Mates With: 50654 terminal

Use With: 35897, 35899, 49016, 49102 and 68507 housings

Designed In: Millimeters

### Electrical

Voltage: 13V

Current: 5.0A max.

Contact Resistance: 5 milliohms max.

Dielectric Withstanding Voltage: 1000V AC

Insulation Resistance: 500V DC 100 Megohms min.

### Mechanical

Contact Insertion Force: 1.5 kgf max.

Contact Retention to Housing: 8.0 kgf min.

Durability: 50 cycles

### Physical

Contact: Brass

Plating: Pre-Tin

# 1.00mm (.040") Tab Wire-to-Wire/ Wire-to-Board 040 111 Housing

68508/64002/35563/35564  
Female, 2 Rows

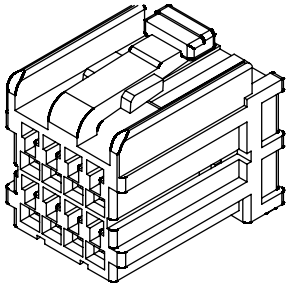

Circuits	Order No.	Color
8	<a href="#">68508-0811</a>	Black
	<a href="#">68508-0815</a>	Gray
12	<a href="#">64002-1210</a>	White
	<a href="#">64002-1215</a>	Gray
16	<a href="#">35563-1610</a>	White
	<a href="#">35563-1615</a>	Gray
20	<a href="#">35564-2010</a>	White
	<a href="#">35564-2015</a>	Gray

## Features and Benefits

- Meets industry-standard requirements for 040 automotive interface
- Side Terminal Position Assurance (TPA) feature virtually eliminates terminal backout
- Rugged contact design offers increased life cycle durability and mechanical and electrical reliability
- Fully shrouded to protect contacts

## Reference Information

Product Specification: PS-68145-002  
Packaging: Bag  
Mates With: 53874, 68145 and 68151  
Use With: 50654  
Designed In: Millimeters

## Electrical

Voltage: 13V  
Current: 5.0A max.  
Contact Resistance: 5 milliohms max.  
Dielectric Withstanding Voltage: 1000V AC  
Insulation Resistance: 500V DC 100 Megohms min.

## Mechanical

Contact Insertion Force: 1.5 kgf max.  
Contact Retention to Housing: 8.0 kgf min.

Circuits	Mating Force (kgf. max.)	Unmating Force (kgf. max.)
8	10	10
12		
16	15	15
20		

Durability: 50 cycles

## Physical

Housing: Polyester, UL 94-HB

[www.molex.com/customer.html?seriesNumber=68508](http://www.molex.com/customer.html?seriesNumber=68508)

# 1.00mm (.040") Tab Wire-to-Wire 040 III Housing

68507/64002  
Male, 8 Circuits, 2 Rows

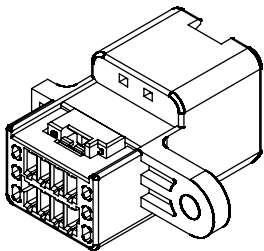

Circuits	Order No.	Type
8	<a href="#">68507-0811</a>	Screw
	<a href="#">68507-0821</a>	Clip
12	<a href="#">64002-1210</a>	Screw
	<a href="#">64002-1215</a>	

## Features and Benefits

- Meets industry-standard requirements for 040 automotive interface
- Side Terminal Position Assurance (TPA) feature virtually eliminates terminal backout
- Rugged contact design offers increased life cycle durability, and mechanical and electrical reliability
- Side flange provides panel mounting retention
- Fully shrouded to protect contacts

## Reference Information

Product Specification: PS-35896-001 and PS-68507-003  
Packaging: Bag  
Mates With: 68508, 64022  
Use With: 50654 and 50660  
Designed In: Millimeters

## Electrical

Voltage: 13V  
Current: 5.0A max.  
Contact Resistance: 5 milliohms max.  
Dielectric Withstanding Voltage: 1000V AC  
Insulation Resistance: 500V DC 100 Megohms min.

## Mechanical

Contact Insertion Force: 1.5 kgf max.  
Contact Retention to Housing: 8.0 kgf min.  
Mating Force: 10 kgf max.  
Unmating Force: 10 kgf max.  
Durability: 50 cycles

## Physical

Housing: Polyester, UL 94-HB

# 1.00mm (.040") Tab Wire-to-Board 040 III Header 68145/68151-XX1X Vertical

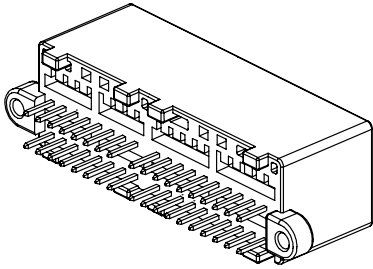

Circuits	Order No.	Color	Lead-free
8	<a href="#">68145-0811</a>	Black	Yes
	<a href="#">68145-0815</a>	Gray	
12	<a href="#">68145-1211</a>	Black	
	<a href="#">68145-1215</a>	Gray	
16	<a href="#">68145-1615</a>		
20	<a href="#">68151-2015</a>		
28	<a href="#">68145-2815</a>		
	<a href="#">68145-2811</a>	Gray	
36	<a href="#">68145-3615</a>		

### Features and Benefits

- Meets industry-standard requirements for 040 automotive interface
- Rugged contact design offers increased life cycle durability and mechanical and electrical reliability
- Fully shrouded to protect contacts

### Reference Information

Product Specification: PS-68145-002 and PS-68145-005  
 Packaging: Tray  
 Mates With: 35563, 35564, 64002 and 68508  
 Use With: 50654  
 Designed In: Millimeters

### Electrical

Voltage: 13V  
 Current: 5.0A max.  
 Contact Resistance: 10 milliohms max.  
 Dielectric Withstanding Voltage: 1000V AC  
 Insulation Resistance: 500V DC 100 Megohms min.

### Mechanical

Contact Insertion Force: 1.5 kgf max.  
 Contact Retention to Housing: 8.0 kgf min.

Circuits	Mating Force (kgf. max.)	Unmating Force (kgf. max.)
8	10	10
12		
16	15	15
20		
28	18	18
36		

Durability: 50 cycles

### Physical

Housing: Polyester, UL 94-HB  
 Contact: Brass  
 Plating: Contact Area—Tin  
           Solder Tail Area—Tin  
 Underplating: Copper  
 PCB Thickness: 1.6mm (.062")

# 1.00mm (.040") Tab Wire-to-Board 040 III Header 68145/68151-XX2X Right Angle

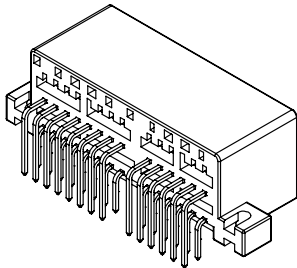

Circuits	Order No.	Color	Lead-free
8	<a href="#">68145-0821</a>	Black	Yes
	<a href="#">68145-0825</a>	Gray	
12	<a href="#">68145-1221</a>	Black	
	<a href="#">68145-1225</a>	Gray	
16	<a href="#">68145-1625</a>		
20	<a href="#">68151-2025</a>		
28	<a href="#">68145-2825</a>		
	<a href="#">68145-2821</a>	Black	
36	<a href="#">53874-3615</a>		

### Features and Benefits

- Meets industry-standard requirements for 040 automotive interface
- Rugged contact design offers increased life cycle durability and mechanical and electrical reliability
- Fully shrouded to protect contacts

### Reference Information

Product Specification: PS-68145-002 and PS-68145-005  
 Packaging: Tray  
 Mates With: 35563, 35564, 64002 and 68508  
 Use With: 50654  
 Designed In: Millimeters

### Electrical

Voltage: 13V  
 Current: 5.0A max.  
 Contact Resistance: 5 milliohms max.  
 Dielectric Withstanding Voltage: 1000V AC  
 Insulation Resistance: 500V DC 100 Megohms min.

### Mechanical

Contact Insertion Force: 1.5 kgf max.  
 Contact Retention to Housing: 8.0 kgf min.  
 Mating Force: 15 kgf max.  
 Unmating Force: 15 kgf max.  
 Durability: 50 cycles

### Physical

Housing: Polyester, UL 94-HB  
 Contact: Brass  
 Plating: Contact Area—Tin  
           Solder Tail Area—Tin  
 Underplating: Copper  
 PCB Thickness: 1.6mm (.062")

## 2.30mm (.090") Tab Terminal

**35421**  
Female

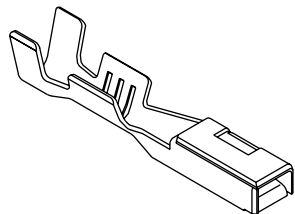

Order No.	Wire Range (mm <sup>2</sup> )	Lead-free
<a href="#">35421-6702</a>	AVS (CAVS) 0.30 to 0.50 (.012 to .020)	Yes
<a href="#">35421-6802</a>	AVS (CAVS) 0.50 to 1.25 (.020 to .050)	
<a href="#">35421-6902</a>	AVSS 2f	

### Features and Benefits

- Housing-locking feature avoids deformation of terminal
- Accepts wide wire range (0.3 to 2.0mm<sup>2</sup>)

### Reference Information

Product Specification: PS-35282  
 Packaging: Reel  
 Mates With: 35420-9702/9802/9902  
 Use With: 35284 housing  
 Designed In: Millimeters

### Electrical

Voltage: 13V  
 Current:

Wire Size	Current
0.3	6A
0.5	8A
0.85	10A
1.25	14A
2.0	18A

Contact Resistance: 3 milliohms max.  
 Dielectric Withstanding Voltage: 1000V AC  
 Insulation Resistance: 500V DC 100 Megohms min.

### Mechanical

Contact Insertion Force: 1.5 kgf max.  
 Contact Retention to Housing: 10 kgf min.  
 Durability: 50 cycles

### Physical

Contact: Copper Alloy  
 Plating: Tin

[www.molex.com/customer.html?seriesNumber=35421](http://www.molex.com/customer.html?seriesNumber=35421)

## 2.30mm (.090") Tab Terminal

**57919**  
Male

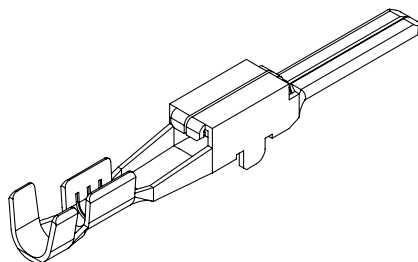

Transportation Products

Order No.	Wire Range (mm <sup>2</sup> )	Insulation Diameter	Lead-free
<a href="#">57919-6702</a>	0.3-0.5	2.60mm (.102") max.	Yes
<a href="#">57919-6802</a>	0.85-1.25	2.90mm (.115") max.	
<a href="#">57919-6902</a>	2.0		

### Features and Benefits

- Locking tab secures terminal to housing

### Reference Information

Product Specification: PS-35896-2090  
 Packaging: Reel  
 Mates With: 35421 Terminal  
 Use With: 35897 and 49016 housings  
 Designed In: Millimeters

### Electrical

Voltage: 13V  
 Current:

Wire Size	Current
0.3	6A
0.5	8A
0.85	10A
1.25	14A
2.0	18A

Contact Resistance: 3 milliohms max.  
 Contact Resistance: 10 milliohms max.  
 Dielectric Withstanding Voltage: 1000V AC  
 Insulation Resistance: 500V DC 100 Megohms min.

### Mechanical

Contact Insertion Force: 1.5 kgf max.  
 Contact Retention to Housing: 10 kgf min.  
 Durability: 50 cycles

### Physical

Contact: Brass  
 Plating: Pre-Tin

**1.00/2.30mm  
(.040/.090") Tab  
Wire-to-Wire  
0409 Hybrid Housing  
49014/35898/35896  
Female**

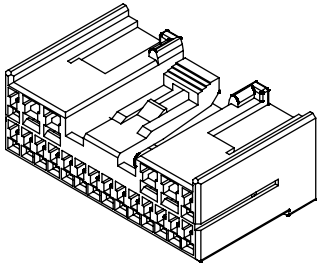

**Features and Benefits**

- Meets industry-standard requirements for 040/090 automotive interface
- Side Terminal Position Assurance (TPA) feature virtually eliminates terminal backout
- Rugged contact design offers increased life cycle durability, and mechanical and electrical reliability
- Side flange provides panel mounting retention
- Fully shrouded to protect contacts
- Hybrid structure:  
1.00mm (.040") terminals for signal circuits  
2.30mm (.090") terminals for normal circuits

Circuits	Signal	Normal
20	16	4
22	18	
24	20	

**Reference Information**

Product Specification: PS-35896-001 and PS-68507-003  
Packaging: Bag  
Mates With: 35897, 35899 and 49016  
Use With: 35421 and 50654  
Designed In: Millimeters

**Electrical**

Voltage: 13V  
Current: 5.0A max. (.040")  
10.0A max. (.090")  
Contact Resistance: 3 milliohms max. (090)  
5 milliohms max. (040)  
Dielectric Withstanding Voltage: 1000V AC  
Insulation Resistance: 500V DC 100 Megohms min.

**Mechanical**

Contact Insertion Force: 1.5 kgf max.  
Contact Retention to Housing: 8 kgf min. (040)  
10 kgf min (090)

Circuits	Mating Force (kgf. max.)	Unmating Force (kgf. max.)
10	14	14
14	18	18
20		
22		
24		

Durability: 50 cycles

**Physical**

Housing: White Polyester, UL 94-HB

Circuits	Order No.
14	<a href="#">35898-1410</a>
20	<a href="#">35896-2010</a>
22	<a href="#">35896-2210</a>
24	<a href="#">35896-2410</a>

[www.molex.com/customer.html?seriesNumber=49014](http://www.molex.com/customer.html?seriesNumber=49014)

**1.00/2.30mm  
(.040/.090") Tab  
Wire-to-Wire  
0409 Hybrid Housing  
35897  
Male**

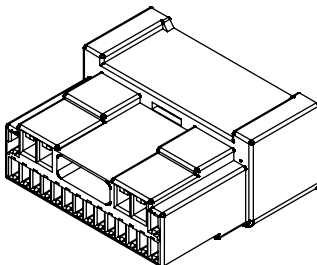

**Features and Benefits**

- Meets industry-standard requirements for 040/090 automotive interface
- Side Terminal Position Assurance (TPA) feature virtually eliminates terminal backout
- Rugged contact design offers increased life cycle durability, and mechanical and electrical reliability
- Side flange provides panel mounting retention
- Fully shrouded to protect contacts

**Reference Information**

Product Specification: PS-35896-2090  
Packaging: Bag  
Mates With: 35896  
Use With: 50660 and 57919  
Designed In: Millimeters

**Electrical**

Voltage: 13V  
Current: 5.0A max. (.040")  
10.0A max. (.090")  
Contact Resistance: 3 milliohms max. (090)  
5 milliohms max. (040)  
Dielectric Withstanding Voltage: 1000V AC  
Insulation Resistance: 500V DC 100 Megohms min.

**Mechanical**

Contact Insertion Force: 1.5 kgf min.  
Contact Retention to Housing: 8 kgf min. (040)  
10 kgf min (090)

Mating Force: 18 kgf max.  
Unmating Force: 18 kgf max.  
Durability: 50 cycles

**Physical**

Housing: Polyester, UL 94-HB

Circuits	Order No.
20	<a href="#">35897-2010</a>
22	<a href="#">35897-2210</a>
24	<a href="#">35897-2410</a>



## 2.54mm (.100") Pitch Stac64™ Header

**34695**  
Vertical  
Single-Bay Hybrid

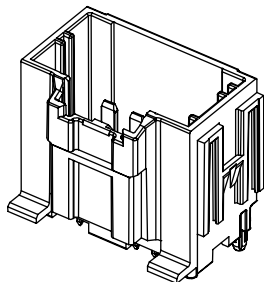

### Features and Benefits

- PCB alignment posts ensure all terminals are properly aligned into PCB through-holes during assembly and retain header to PCB during assembly and solder processing
- PCB stand-offs molded into housings provide additional trace-routing real estate under the headers
- High temperature thermoplastic housings withstand infra red (IR) and wave lead-free solder processing per ES-40000-5013 Molex specification
- Stackable connection system of readily available PCB headers ensure reduced time-to-market: engineering and validation times reduced significantly, no tooling necessary to produce custom multi-bay headers
- Pre-assembled, linear Mylar PC tail alignment strip for right-angle headers reduces PCB packaging complexity and provides space savings
- The header housings are molded in standard USCAR color schemes for additional polarizations to match harness connector color-coding scheme for visual aid in assembly
- Modular-housing design with standard dovetail features molded into the housings allows headers to be ganged together in large assemblies to meet growing terminal quantity requirements

### Reference Information

Packaging: Male Headers—Tray  
Mates With: Series 31372 female connectors  
Designed In: Millimeters

### Electrical

Voltage: 500V max.  
Current: 2.80mm (.110")—30.0A max.  
1.50mm (.059")—18.0A max.  
Dielectric Withstanding Voltage: 500V DC  
Isolation Resistance: 20 Megohms min.  
Durability: 10 milliohms max.—10 cycles  
Header Pin retention Force:  
2.80mm (.110")—70N (15.7 lb) min.  
1.50mm (.059")—70N (15.7 lb) min.

### Physical

Header Housings: Glass filled SPS

Contact:

2.80mm (.110") blades—Copper Alloy  
1.50mm (.059") blades—Copper Alloy

Plating:

1.50mm (.059") blades: Overplating—Tin  
Underplating—Nickel  
2.80mm (.110") blades: Overplating—Tin  
Underplating—Nickel

Circuit Size	Order No.	Polarization Option	Color	Packaging	Assembly Features	Headers
10	<a href="#">34695-0100</a>	A	Black	Tray	Housing and Blades Assembly	Power
	<a href="#">34695-0101</a>	B	Grey			

## 2.54mm (.100") Pitch Stac64™ Header

**34690**  
Vertical  
Single-Bay

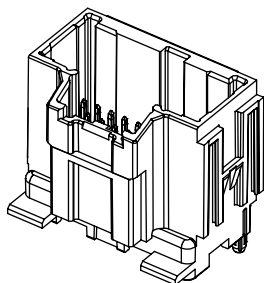

### Features and Benefits

- PCB alignment posts ensure all terminals are properly aligned into PCB through-holes during assembly and solder processing
- PCB stand-offs molded into housings provide additional trace-routing real estate under the headers
- High temperature thermoplastic housings withstand infra red (IR) and wave lead-free solder processing per ES-40000-5013 Molex specification
- Stackable connection system of readily available PCB headers ensure reduced time-to-market: engineering and validation times reduced significantly, no tooling necessary to produce custom multi-bay headers
- The header housings are molded in standard USCAR color schemes for additional polarizations to match harness connector color-coding scheme for visual aid in assembly
- Modular-housing design with standard dovetail features molded into the housings allows headers to be ganged together in large assemblies to meet growing terminal quantity requirements

### Reference Information

Packaging: Male Vertical Headers—Tray or Tube  
Mates With: Series 34729 female connectors  
Designed In: Millimeters

### Electrical

Voltage: 500V max.  
Current: 0.64mm (.025")—8.0A max.  
Dielectric Withstanding Voltage: 500V DC  
Isolation Resistance: 20 Megohms min.

### Mechanical

Durability: 10 milliohms max.—10 cycles  
Header Pin Retention Force:  
0.64mm (.025")—15N (3.4 lb) min.

### Physical

Header Housings: Glass filled SPS

Contact: 0.64mm (.025") pins—Copper Alloy

Plating:

0.64mm (.110") signal pins: Overplating—Tin  
Underplating—Nickel

Circuit Size	Order No.	Polarization Option	Color
8	<a href="#">34690-0080</a>	A	Black
	<a href="#">34690-0081</a>	B	Grey
	<a href="#">34690-0082</a>	C	Brown
12	<a href="#">34690-0120</a>	A	Black
	<a href="#">34690-0121</a>	B	Grey
	<a href="#">34690-0122</a>	C	Brown
16	<a href="#">34690-0160</a>	A	Black
	<a href="#">34690-0161</a>	B	Grey
	<a href="#">34690-0162</a>	C	Brown
20	<a href="#">34690-0200</a>	A	Black
	<a href="#">34690-0201</a>	B	Grey
	<a href="#">34690-0202</a>	C	Brown
	<a href="#">34690-0203</a>	D	Green



# 0.64mm (.025") CTX64 Crimp Terminal

## 34803 Female

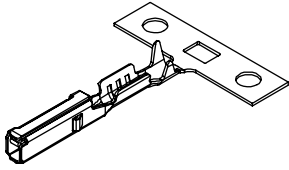

### Features and Benefits

- Excellent stress-relaxation properties
- One-piece design to keep cost low
- Clean-body design to insert through matte seal
- Accommodates ISO/JASO and SAE wires
- Lead free
- Compatible to competitor's RH-terminal cavity
- Single polarization

### Reference Information

Product Specification: PS-502306-001  
Packaging: Reel  
Mates With: 0.64mm wide by 0.64mm thick blade  
Use With: 34729, 98833 and 502725  
Designed In: Millimeters

### Electrical

Voltage: 250V  
Current: 7.0A  
Contact Resistance: 5 milliohms max.

### Mechanical

Wire Pull-Out Force: 0.85mm<sup>2</sup>—130N min.  
0.22mm<sup>2</sup>—40N min  
Mating Force: 4N max.  
Unmating Force: 4N max.  
Durability: 10 mates max.

### Physical

Contact: Copper alloy  
Plating: Contact Area—Tin  
Solder Tail Area—Tin  
Underplating—Nickel  
Insulation Diameter: 1.9mm max.  
Wire Gauge: 0.22 to 0.85mm<sup>2</sup>

Order No.		Polarization Option See Inset	Grip Code	Wire Gauge			Plating
D-Wind (Left Payoff)	B-Wind (Right Payoff)			ISO (mm <sup>2</sup> )	JASO (mm <sup>2</sup> )	SAE (gauge)	
<a href="#">34803-0211</a>	<a href="#">34803-0213</a>	Dual	S	0.22-0.35	0.3	22	Tin
<a href="#">34803-0212</a>	<a href="#">34803-0214</a>		L	0.50-0.75	0.50-0.85	20	

# 2.54mm (.100") Pitch Stac64™ Signal Receptacle

## 34729

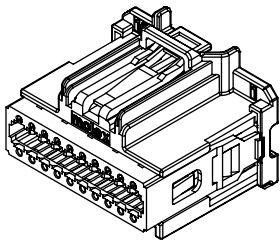

### Features and Benefits

- Pre-assembled TPA to receptacle housing shipped as single assembly provide applied labor and cost savings

### Reference Information

Packaging: Female Receptacle Connectors—Bulk Pack  
Mates With: Series 34690, 34691 male unsealed headers  
Use With Terminals:  
0.64mm (.059") female—Series 502306  
Designed In: Millimeters

### Electrical

Voltage: 500V max.  
Current: 0.64mm (.025")—8.0A max.  
Contact Resistance: 0.64mm (.025")—20 milliohms max.  
Dielectric Withstanding Voltage: 500V DC  
Isolation Resistance: 20 Megohms min.

### Mechanical

Connector Retention (Primary latch): 110N (24.7 lb) min.  
Contact Retention to Housing:  
0.64mm (.025")—75N (16.9 lb) min. with TPA,  
30N (6.7 lb) without TPA  
Contact Insertion Force Into Housing: 30N (6.7 lb) max.  
Connector Audible Feedback: 7dB over ambient  
Durability: 10 milliohms max.—10 cycles  
TPA Insertion Force: 60N (13.5 lb) max.  
TPA Extraction Force: 60N (13.5 lb) max.  
Thermal Shock (Class 2, 100 cycles):  
0.64mm (.025")—20 milliohms max.  
Vibration/Mechanical Shock (electrical):  
0.64mm (.025")—20 milliohms max.  
Temperature/Humidity (electrical):  
0.64mm (.025")—20 milliohms max.  
High Temperature Exposure (electrical):  
0.64mm (.025")—20 milliohms max.

### Physical

Harness Housings: Glass filled SPS/nylon blend  
TPA: 15% glass filled polyester

Circuit Size	Order No.	Polarization Option	Color	Assembly Features	Comment
8	<a href="#">34729-0080</a>	A	Black	Housing and TPA Assembly	0.64mm (.025") terminal size USCAR receptacle connectors
	<a href="#">34729-0081</a>	B	Grey		
	<a href="#">34729-0082</a>	C	Brown		
12	<a href="#">34729-0120</a>	A	Black		
	<a href="#">34729-0121</a>	B	Grey		
	<a href="#">34729-0122</a>	C	Brown		
16	<a href="#">34729-0160</a>	A	Black		
	<a href="#">34729-0161</a>	B	Grey		
	<a href="#">34729-0162</a>	C	Brown		
20	<a href="#">34729-0200</a>	A	Black		
	<a href="#">34729-0201</a>	B	Grey		
	<a href="#">34729-0202</a>	C	Brown		
	<a href="#">34729-0203</a>	D	Green		

## 2.54mm (.100") Pitch Stac64™ Header

**34696**  
Right Angle  
Single-Bay Hybrid

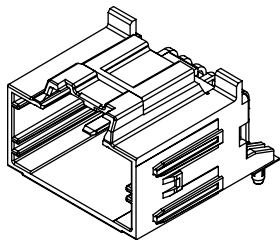

### Features and Benefits

- PCB alignment posts ensure all terminals are properly aligned into PCB through-holes during assembly and retain header to PCB during assembly and solder processing
- PCB stand-offs molded into housings provide additional trace-routing real estate under the headers
- High temperature thermoplastic housings withstand infra red (IR) and wave lead-free solder processing per ES-40000-5013 Molex specification
- Stackable connection system of readily available PCB headers ensure reduced time-to-market: engineering and validation times reduced significantly, no tooling necessary to produce custom multi-bay headers
- The header housings are molded in standard USCAR color schemes for additional polarizations to match harness connector color-coding scheme for visual aid in assembly
- Modular-housing design with standard dovetail features molded into the housings allows headers to be ganged together in large assemblies to meet growing terminal quantity requirements

### Reference Information

Packaging: Male Headers—Tray or Tube  
Mates With: Series 31372 female connectors  
Designed In: Millimeters

### Electrical

Voltage: 500V max.  
Current: 2.80mm (.110")—30.0A max.  
1.50mm (.059")—18.0A max.  
Dielectric Withstanding Voltage: 500V DC  
Isolation Resistance: 20 Megohms min.  
Polarization Feature Effectiveness: 220N (49.5 lb) min.  
Durability: 10 milliohms max.—10 cycles  
Header Pin retention Force:  
2.80mm (.110")—70N (15.7 lb) min.  
1.50mm (.059")—70N (15.7 lb) min.

### Physical

Header Housings: Glass filled SPS  
Contact:  
2.80mm (.110") blades—Copper Alloy  
1.50mm (.059") blades—Copper Alloy  
Plating: 1.50mm (.059") blades:  
Overplating—Tin  
Underplating—Nickel  
2.80mm (.110") blades: Overplating—Tin  
Underplating—Nickel

Circuit Size	Order No.	Polarization Option	Color	Packaging	Assembly Features	Headers
10	<a href="#">34695-0100</a>	A	Black	Tray	Housing and Blades Assembly	Power
	<a href="#">34695-0101</a>	B	Grey			
	<a href="#">34695-9100</a>	A	Black	Tube		
	<a href="#">34695-9101</a>	B	Grey			

## 2.54mm (.100") Pitch Stac64™ Header

**34691**  
Right Angle  
Single-Bay

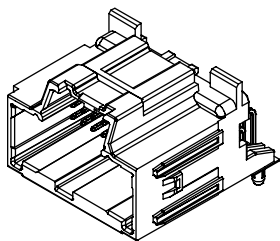

### Features and Benefits

- PCB alignment posts ensure all terminals are properly aligned into PCB through-holes during assembly and retain header to PCB during assembly and solder processing
- PCB stand-offs molded into housings provide additional trace-routing real estate under the headers
- High temperature thermoplastic housings withstand infra red (IR) and wave lead-free solder processing per ES-40000-5013 Molex specification
- Stackable connection system of readily available PCB headers ensure reduced time-to-market: engineering and validation times reduced significantly, no tooling necessary to produce custom multi-bay headers
- The header housings are molded in standard USCAR color schemes for additional polarizations to match harness connector color-coding scheme for visual aid in assembly
- Modular-housing design with standard dovetail features molded into the housings allows headers to be ganged together in large assemblies to meet growing terminal quantity requirements

### Reference Information

Packaging: Male Vertical Headers—Tray  
Mates With: Series 34729 female connectors  
Designed In: Millimeters

### Electrical

Voltage: 500V max.  
Current: 0.64mm (.025")—8.0A max.  
Dielectric Withstanding Voltage: 500V DC  
Isolation Resistance: 20 Megohms min.

### Mechanical

Durability: 10 milliohms max.—10 cycles  
Header Pin retention Force:  
0.64mm (.025")—15N (3.4 lb) min.

### Physical

Header Housings: Glass filled SPS  
Contact: 0.64mm (.025") pins—Copper Alloy  
Plating: 0.64mm (.110") signal pins:  
Overplating—Tin  
Underplating—Nickel

Circuit Size	Order No.	Polarization Option	Color
8	<a href="#">34691-0080</a>	A	Black
	<a href="#">34691-0081</a>	B	Grey
	<a href="#">34691-0082</a>	C	Brown
12	<a href="#">34691-0120</a>	A	Black
	<a href="#">34691-0121</a>	B	Grey
	<a href="#">34691-0122</a>	C	Brown
16	<a href="#">34691-0160</a>	A	Black
	<a href="#">34691-0161</a>	B	Grey
	<a href="#">34691-0162</a>	C	Brown
20	<a href="#">34691-0200</a>	A	Black
	<a href="#">34691-0201</a>	B	Grey
	<a href="#">34691-0202</a>	C	Brown
	<a href="#">34691-0203</a>	D	Green

# 2.54mm (.100") Pitch Stac64™ Hybrid Receptacle

31372

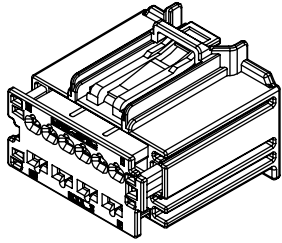

### Features and Benefits

- Pre-assembled TPA to receptacle housing shipped as single assembly provide applied labor and cost savings

### Reference Information

Packaging: Female Receptacle Connectors—Bulk Pack

Male Vertical Headers—Tray

Mates With: Series 34695, 34696 male unsealed headers

Use With Terminals:

1.50mm (.059") female—Molex 33012-2001, -2002, -2003

2.80mm (.110") female—Tyco and Yazaki

Tooling: Molex & Tyco Electronics

Designed In: Millimeters

### Electrical

Voltage: 500V max.

Current: 2.80mm (.110")—30.0A max.

1.50mm (.059")—18.0A max.

Contact Resistance: 2.80mm (.110")—5 milliohms max.

1.50mm (.059")—10 milliohms max.

Dielectric Withstanding Voltage: 500V DC

Isolation Resistance: 20 Megohms min.

### Mechanical

Mating Force: Less than 75N (16.9 lb)

Unmating Force: Less than 75N (19.1 lb)

Connector Retention (Primary latch): 110N (24.7 lb) min.

Contact Retention to Housing: 2.80mm (.110")—90N

(20.2 lb) min. with TPA, 60N (13.5 lb) without TPA

1.50mm (.059")—85N (19.1 lb) min. with TPA,

45N (10.1 lb) without TPA

Contact Insertion Force Into Housing: 30N (6.7 lb) max.

Connector Audible Feedback: 7dB over ambient

Durability: 10 milliohms max.—10 cycles

TPA Insertion Force: 60N (13.5 lb) max.

TPA Extraction Force: 60N (13.5 lb) max.

Thermal Shock (Class 2, 100 cycles):

2.80mm (.110")—5 milliohms max.

1.50mm (.059")—10 milliohms max.

Vibration/Mechanical Shock (electrical):

2.80mm (.110")—5 milliohms max.

1.50mm (.059")—10 milliohms max.

Temperature/Humidity (electrical):

2.80mm (.110")—5 milliohms max.

1.50mm (.059")—10 milliohms max.

High Temperature Exposure (electrical):

2.80mm (.110")—5 milliohms max.

1.50mm (.059")—10 milliohms max.

### Physical

Harness Housings: glass filled SPS/nylon blend

TPA: 15% glass filled polyester

Contact:

2.80mm (.110") blades—Copper Alloy

1.50mm (.059") blades—Copper Alloy

Plating: 1.50mm (.059") blades:

Overplating—Tin

Underplating—Nickel 1.50mm (.059")

Receptacle Terminals: Overplating—Tin

Underplating—Nickel

2.80mm (.110") blades: Overplating—Tin

Underplating—Nickel

Circuit Size	Order No.	Polarization Option	Color	Comment
10	<a href="#">31372-1000</a>	A	Black	1.50 and 2.80mm (.059 and .110") terminal size hybrid receptacle connectors
	<a href="#">31372-1001</a>	B	Grey	

# 2.54mm (.100") Pitch Stac64™ Header

## 34707 Vertical Ganged Multi-Bay

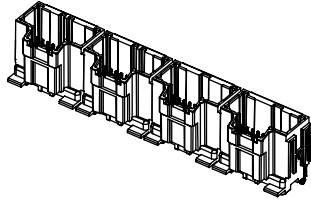

### Features and Benefits

- PCB alignment posts ensure all terminals are properly aligned into PCB through-holes during assembly and retain header to PCB during assembly and solder processing
- High temperature thermoplastic housings withstand infra red (IR) and wave lead-free solder processing per ES-40000-5013 Molex specification
- Stackable connection system of readily available PCB headers ensure reduced time-to-market: engineering and validation times reduced significantly, no tooling necessary to produce custom multi-bay headers
- The header housings are molded in standard USCAR color schemes for additional polarizations to match harness connector color-coding scheme for visual aid in assembly
- Modular-housing design with standard dovetail features molded into the housings allows headers to be ganged together in large assemblies to meet growing terminal quantity requirements

### Reference Information

Packaging: Male Headers—Tray or Tube  
Mates With: Series 34729 and 31372 female connectors  
Designed In: Millimeters

### Electrical

Voltage: 500V max.  
Current: 2.80mm (.110")—30.0A max.  
1.50mm (.059")—22.0A max.  
0.64mm (.025")—8.0A max.  
Dielectric Withstanding Voltage: 500V DC  
Isolation Resistance: 20 Megohms min.

### Mechanical

Durability: 10 milliohms max.—10 cycles  
Header Pin retention Force:  
2.80mm (.110")—70N (15.7 lb) min.  
1.50mm (.059")—70N (15.7 lb) min.  
0.64mm (.025")—15N (3.4 lb) min.

### Physical

Header Housings: Glass filled SPS  
Contact:  
2.80mm (.110") blades—Copper Alloy  
1.50mm (.059") blades—Copper Alloy  
0.64mm (.025") pins—Copper Alloy  
Plating: 0.64mm (.110") signal pins:  
Overplating—Tin  
Underplating—Nickel  
1.50mm (.059") blades: Overplating—Tin  
Underplating—Nickel  
2.80mm (.110") blades: Overplating—Tin  
Underplating—Nickel

Order No.	No. of Bays	Circuit Sizes by Bay	Assembly Features	Headers
<a href="#">34707-2000</a>	2	20 by 20	Housing and Pins Assembly	Signal
<a href="#">34707-2002</a>		10 by 20	Housing, Pins and Blades Assembly	Signal and Power
<a href="#">34707-2012</a>		20 by 10	Housing and Blades Assembly	
<a href="#">34707-2022</a>		10 by 10	Housing, Pins and Blades Assembly	Power
<a href="#">34707-2030</a>		4	20 by 20 by 20 by 20	Housing and Pins Assembly
<a href="#">34707-4000</a>				

Note: Other configurations available, contact Molex

# 2.54mm (.100") Pitch Stac64™ Header

## 34708 Right Angle Ganged Multi-Bay

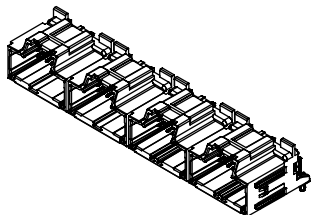

### Features and Benefits

- PCB alignment posts ensure all terminals are properly aligned into PCB through-holes during assembly and retain header to PCB during assembly and solder processing
- High temperature thermoplastic housings withstand infra red (IR) and wave lead-free solder processing per ES-40000-5013 Molex specification
- Stackable connection system of readily available PCB headers ensure reduced time-to-market: engineering and validation times reduced significantly, no tooling necessary to produce custom multi-bay headers
- The header housings are molded in standard USCAR color schemes for additional polarizations to match harness connector color-coding scheme for visual aid in assembly
- Modular-housing design with standard dovetail features molded into the housings allows headers to be ganged together in large assemblies to meet growing terminal quantity requirements

### Reference Information

Packaging: Male Headers—Tray or Tube

Mates With: Series 34729 and 31372 female connectors

Designed In: Millimeters

### Electrical

Voltage: 500V max.

Current: 2.80mm (.110")—30.0A max.

1.50mm (.059")—22.0A max.

0.64mm (.025")—8.0A max.

Dielectric Withstanding Voltage: 500V DC

Isolation Resistance: 20 Megohms min.

### Mechanical

Durability: 10 million cycles max.—10 cycles

Header Pin Retention Force:

2.80mm (.110")—70N (15.7 lb) min.

1.50mm (.059")—70N (15.7 lb) min.

0.64mm (.025")—15N (3.4 lb) min.

### Physical

Header Housings: Glass filled SPS

Contact:

2.80mm (.110") blades—Copper Alloy

1.50mm (.059") blades—Copper Alloy

0.64mm (.025") pins—Copper Alloy

Plating: 0.64mm (.110") signal pins:

Overplating—Tin

Underplating—Nickel

1.50mm (.059") blades: Overplating—Tin

Underplating—Nickel

2.80mm (.110") blades: Overplating—Tin

Underplating—Nickel

Order No.	No. of Bays	Circuit Sizes by Bay	Assembly Features	Headers
<a href="#">34708-2000</a>	2	20 by 20	Housing, Blades and Mylar Assembly	Signal
<a href="#">34708-2012</a>		10 by 20	Housing, Pins, Blades and Mylar Assembly	Signal and Power
<a href="#">34708-2022</a>		20 by 10		
<a href="#">34708-2030</a>		10 by 10	Housing, Blades and Mylar Assembly	Power
<a href="#">34708-4000</a>	4	20 by 20 by 20 by 20	Housing, Pins and Mylar Assembly	Dense Signal

Note: Other configurations available, contact Molex

# 2.54mm (.100") Pitch H-DAC 64™ Header

## 31101 Vertical Single Row

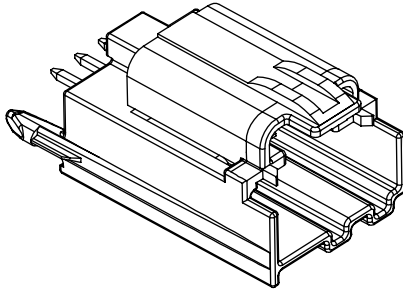

### Features and Benefits

- Versatile product selection
- Scoop-proof housing
- Three standard polarizations in 3 colors
- TPA feature
- Positive-lock provides audible click
- Optional clip slot feature

### Reference Information

Product Specifications: PS-31067-0001 (single row)  
PS-31101-0001 (headers)

Packaging: Bag

Mates With:

Male and Female

Single Row—31067, 31068, 31072 and 31073

Headers—31100 and 31101

Use With: Industry approved male and female terminals  
Designed In: Millimeters

### Electrical

Voltage: 500V

Current: 10A

Contact Resistance: 20 milliohms max.

Dielectric Withstanding Voltage: 500V DC

Insulation Resistance: 20 Megohms min.

### Mechanical

Contact Insertion Force: 30N (6.7 lb)

Contact Retention to Housing: 30N (6.7 lb)

Mating Force: 45N (10.1 lb)

Unmating Force: 45N (10.1 lb)

Durability: 10 cycles

### Physical

Housing: Glass filled SPS

Contact: Copper Alloy

Plating: Overplating—Tin

Underplating—Nickel

Circuits	Order No.	Polarization	Options	Lead-free
4	<a href="#">31101-0040</a>	A	PCB Retention Pegs	Yes
	<a href="#">31101-0041</a>	B		
	<a href="#">31101-0042</a>	C		
	<a href="#">31101-1140</a>	A	Wings	
	<a href="#">31101-1240</a>	B		
	<a href="#">31101-1340</a>	C		

# 2.54mm (.100") Pitch H-DAC 64™ Header

## 31100 Right Angle Single Row

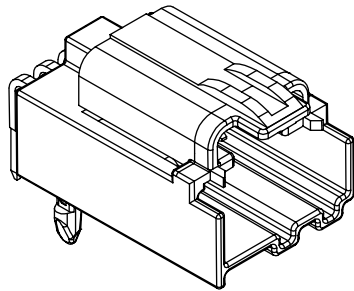

### Features and Benefits

- Versatile product selection
- Scoop-proof housing
- Three standard polarizations in three colors
- TPA feature
- Positive-lock provides audible click
- Optional clip slot feature

### Reference Information

Product Specifications: PS-31067-0001 (single row)  
PS-31101-0001 (headers)

Packaging: Bag

Mates With:

Male and Female

Single Row—31067, 31068, 31072 and 31073

Headers—31100 and 31101

Use With: Industry approved male and female terminals  
Designed In: Millimeters

### Electrical

Voltage: 500V

Current: 10A

Contact Resistance: 20 milliohms max.

Dielectric Withstanding Voltage: 500V DC

Insulation Resistance: 20 Megohms min.

### Mechanical

Contact Insertion Force: 30N (6.7 lb)

Contact Retention to Housing: 30N (6.7 lb)

Mating Force: 45N (10.1 lb)

Unmating Force: 45N (10.1 lb)

Durability: 10 cycles

### Physical

Housing: Glass filled SPS

Contact: Copper Alloy

Plating: Overplating—Tin

Underplating—Nickel

Circuits	Order No.	Polarization	Lead-free
4	<a href="#">31100-0040</a>	A	Yes
	<a href="#">31100-0041</a>	B	
	<a href="#">31100-0042</a>	C	

## 2.54mm (.100") Pitch H-DAC 64™ Male Plug

31067/31068/31072/ 31073  
Single Row

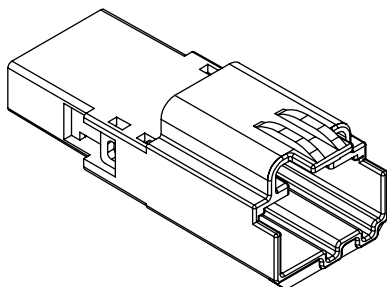

### Features and Benefits

- Versatile product selection
- Scoop-proof housing
- Three standard polarizations
- TPA feature
- Positive-lock provides audible click
- Optional clip slot feature

### Reference Information

Product Specifications: PS-31067-0001 (single row)  
PS-31101-0001 (headers)

Packaging: Bulk

Mates With:

Male and Female

Single Row—31067, 31068, 31072 and 31073

Headers—31100 and 31101

Use With: Industry approved male and female terminals

Designed In: Millimeters

### Electrical

Voltage: 500V

Current: 10A

Contact Resistance: 20 milliohms max.

Dielectric Withstanding Voltage: 500V DC

Insulation Resistance: 20 Megohms min.

### Mechanical

Contact Insertion Force: 30N (6.7 lb)

Contact Retention to Housing: 30N (6.7 lb)

Mating Force: 45N (10.1 lb)

Unmating Force: 45N (10.1 lb)

Durability: 10 cycles

### Physical

Housing: Glass filled SPS

Contact: Copper Alloy

Plating: Overplating—Tin

Underplating—Nickel

Circuits	Order No.	Polarization	Options	Lead-free
3	<a href="#">31067-1040</a>	A	christmas tree attachment	Yes
	<a href="#">31067-1041</a>	B		
	<a href="#">31067-1042</a>	C		
	<a href="#">31067-1070</a>	A		
	<a href="#">31067-1071</a>	B		
	<a href="#">31067-1072</a>	C		
4	<a href="#">31068-1040</a>	A	christmas tree attachment	Yes
	<a href="#">31068-1041</a>	B		
	<a href="#">31068-1042</a>	C		
	<a href="#">31068-1070</a>	A		
	<a href="#">31068-1071</a>	B		
	<a href="#">31068-1072</a>	C		

Circuits	Order No.	Polarization	Options	Lead-free
5	<a href="#">31072-1040</a>	A	christmas tree attachment	Yes
	<a href="#">31072-1041</a>	B		
	<a href="#">31072-1042</a>	C		
	<a href="#">31072-1070</a>	A		
	<a href="#">31072-1071</a>	B		
	<a href="#">31072-1072</a>	C		
6	<a href="#">31073-1040</a>	A	christmas tree attachment	Yes
	<a href="#">31073-1041</a>	B		
	<a href="#">31073-1042</a>	C		
	<a href="#">31073-1070</a>	A		
	<a href="#">31073-1071</a>	B		
	<a href="#">31073-1072</a>	C		

## 2.54mm (.100") Pitch H-DAC 64™ Female Receptacle

31067/31068/31072/31073  
Single Row

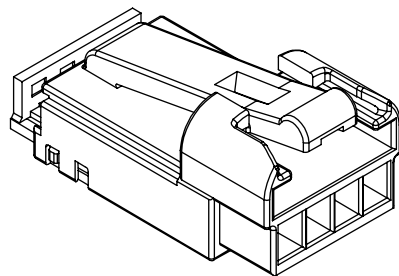

### Features and Benefits

- Versatile product selection
- Scoop-proof housing
- Three standard polarizations
- TPA feature
- Positive-lock provides audible click
- Optional clip slot feature

### Reference Information

Product Specifications: PS-31067-0001 (single row)  
PS-31101-0001 (headers)

Packaging: Bulk

Mates With:

Male and Female

Single Row—31067, 31068, 31072 and 31073

Headers—31100 and 31101

Use With: Industry approved male and female terminals

Designed In: Millimeters

### Electrical

Voltage: 500V

Current: 10A

Contact Resistance: 20 milliohms max.

Dielectric Withstanding Voltage: 500V DC

Insulation Resistance: 20 Megohms min.

### Mechanical

Contact Insertion Force: 30N (6.7 lb)

Contact Retention to Housing: 30N (6.7 lb)

Mating Force: 45N (10.1 lb)

Unmating Force: 45N (10.1 lb)

Durability: 10 cycles

### Physical

Housing: Glass filled SPS

Contact: Copper Alloy

Plating: Overplating—Tin

Underplating—Nickel

Circuits	Order No.	Polarization	Lead-free
3	<a href="#">31067-1010</a>	A	Yes
	<a href="#">31067-1011</a>	B	
	<a href="#">31067-1012</a>	C	
4	<a href="#">31068-1010</a>	A	Yes
	<a href="#">31068-1011</a>	B	
	<a href="#">31068-1012</a>	C	

Circuits	Order No.	Polarization	Lead-free
5	<a href="#">31072-1010</a>	A	Yes
	<a href="#">31072-1011</a>	B	
	<a href="#">31072-1012</a>	C	
6	<a href="#">31073-1010</a>	A	Yes
	<a href="#">31073-1011</a>	B	
	<a href="#">31073-1012</a>	C	



# 2.54mm (.100") Pitch MOX Crimp Terminal

**98658**  
**Female**

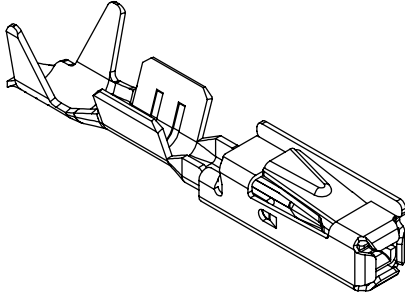

### Features and Benefits

- Two-piece laser-welded terminal
- Two points of contact
- For wire termination
- Two-piece terminal with sleeve design
- Steel sleeve protects mating area
- Polarization rib for terminal orientation during assembly
- Long contact area provides secure electrical connection

### Reference Information

Product Specification: PS-98658-005  
Packaging: Reel  
Mates With: 0.635mm (.025") square pin terminals  
Use With: MOX housings and various other connectors  
Designed In: Millimeters

### Electrical

Voltage: 14V DC  
Current: 6.5A  
Contact Resistance: 8 milliohms max.  
Dielectric Withstanding Voltage: 1000V AC  
Insulation Resistance: 100 Megohms min.

### Mechanical

Contact Insertion Force: 3.0N max.  
Contact Retention to Housing: 40.0N min.  
Wire Pull-Out Force: 50N min. on 0.22mm<sup>2</sup> wire  
Insertion Force to Housing: 5.0N max. (for unsealed);  
10.0N max. (for sealed connector)  
Durability: 20 cycles

### Physical

Contact: High Conductive Copper Alloy, 0.635mm (.025"), square  
Plating: Pre-plated  
Contact Area: Tin—1 to 3μm min.; Gold—0.4μm min.  
Underplating: Nickel (for Gold-plated version only)

Order No.	Plating	Wire Size (AWG)	Wire size (mm <sup>2</sup> )	Wire Insulation Diameter	Wire Strip Length	Lead-free
<a href="#">98658-1211</a>	Tin	20-24	0.22-0.60	1.20-1.80mm (.047-.071")	3.00mm	Yes
<a href="#">98658-1212</a>		18-22	0.75	1.70mm (.067") max	3.50mm	
<a href="#">98658-1213</a>		20-24	0.22-0.50	1.20-1.50mm (.047-.060")	3.00mm	
<a href="#">98658-1221</a>	Select Gold	20-24	0.22-0.60	1.20-1.80mm (.047-.071")	3.00mm	
<a href="#">98658-1222</a>		18-22	0.75	1.70mm (.067") max	3.50mm	
<a href="#">98658-1223</a>		20-24	0.22-0.50	1.20-1.50mm (.047-.060")	3.00mm	
<a href="#">98658-1231</a>	2 points Select Gold	20-24	0.22-0.60	1.20-1.80mm (.047-.071")	3.00mm	
<a href="#">98658-1232</a>		18-22	0.75	1.70mm (.067") max	3.50mm	
<a href="#">98658-1233</a>		20-24	0.22-0.50	1.20-1.50mm (.047-.060")	3.00mm	

# 2.54mm (.100") Pitch MOX Receptacle Housing

**98193**  
**Single Row, Vertical  
With TPA**

### Features and Benefits

- Reusable one-piece secondary locking
- Inertial locking feature
- One-piece design with integrated secondary lock for easy use

### Reference Information

Packaging: Bag  
Use With: 98658  
Designed In: Millimeters

### Electrical

Voltage: 14V DC  
Current: 6.0A  
Contact Resistance: 8 milliohms max.  
Dielectric Withstanding Voltage: 1000V AC  
Insulation Resistance: 100 Megohms min.

### Mechanical

Contact Insertion Force: 5.0N (1.12 lb) max.  
Contact Retention to Housing: 40.0N (9 lb) min.  
Wire Pull-Out Force: 100.0N (22.5 lb) min.  
Mating Force: 60.0N (13.5 lb) max.  
Unmating Force: 60.0N (13.5 lb) max.  
Durability: 20 cycles (with Tin-plated terminal)

### Physical

Housing: Black PA Polyamide (nylon) 6, UL 94V-2

Circuits	Order No.	Lead-free
6	<a href="#">98193-0001</a>	Yes

# 2.54mm (.100") Pitch MOX Receptacle Housing

**98298**

**2 by 3 Circuits  
Dual Row, Vertical  
Breakable**

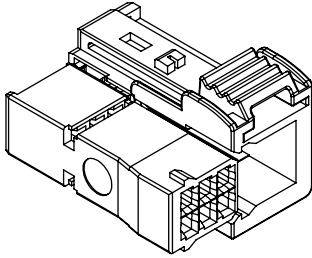

### Features and Benefits

- Reusable two-piece secondary locking feature
- Inertial locking feature
- Six color and mechanical codings
- One-piece design with integrated secondary lock for easy use

### Reference Information

Packaging: Bag  
Mates With: Industry-standard interface  
Use With: 98658  
Designed In: Millimeters

### Electrical

Voltage: 14V DC  
Current: 6.0A  
Contact Resistance: 8 milliohms max.  
Dielectric Withstanding Voltage: 1000V AC  
Insulation Resistance: 100 Megohms min.

### Mechanical

Contact Insertion Force: 5.0N (1.12 lb) max.  
Contact Retention to Housing: 40.0N (9 lb) min.  
Wire Pull-Out Force: 100N (22.5 lb) min.  
Mating Force: 65.0N (14.6 lb) max.  
Unmating Force: 60.0N (13.5 lb) max.  
Durability: 20 cycles (with Tin-plated terminals)

### Physical

Housing: Glass-filled PBT Polyester, HB, UL 94-HB

Circuits	Order No.	Color	Lead-free
6	<a href="#">98298-0001</a>	Black	Yes
	<a href="#">98298-0002</a>	White	
	<a href="#">98298-0003</a>	Green	
	<a href="#">98298-0004</a>	Brown	
	<a href="#">98298-0005</a>	Gray	
	<a href="#">98298-0006</a>	Blue	

[www.molex.com/product/mox.html](http://www.molex.com/product/mox.html)

# 2.54x2.54mm (.100"x.100") Pitch MOX Receptacle Housing

**94552**

**Dual Row, Breakable  
8/12 Circuits**

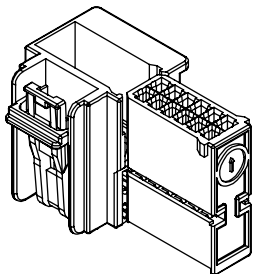

### Features and Benefits

- One-piece housing and secondary locking
- Breakable configuration
- Ease of use
- MQS compatible
- According to USCAR standard

### Reference Information

Packaging: PK-94552-001  
Mates With: 31341 series  
Use With: 98658 series terminals  
Designed In: Millimeters

### Electrical

Voltage: 125 V RMS  
Current: 7.5A max.  
Contact Resistance: 7 milliohms max.  
Dielectric Withstanding Voltage: 1000 V max.  
Insulation Resistance: 10 Megohms min.

### Mechanical

Contact Insertion Force into Housing: 15N (3.4 lb) max.  
Contact Retention to Housing: 60N (13.5 lb) max.  
Wire Pull-Out Force: 50N min.  
Mating Force: 75N min.  
Unmating Force: 75N min.  
Durability: 20 cycles

### Physical

Housing: PBT 20% G.F.

Circuits	Order No.	Polarization	Lead-Free
8	<a href="#">94552-9008</a>	B	Yes
12	<a href="#">94552-9012</a>	A	

# 2.54mm (.100") Pitch MOX Receptacle Housing

**98615**

**Dual Row, 64 Circuits**

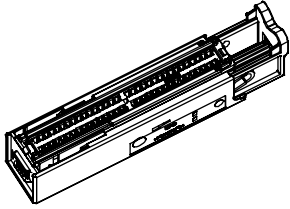

Order No.	Version	Lead-Free
<a href="#">98615-1001</a>	Flex	Yes
<a href="#">98615-1002</a>	Wire	

### Features and Benefits

- Slide locking assistance
- Design compatible with wire version (0986151002) or FFC version (0986151001)
- Wire cap available
- Secondary locking

### Reference Information

Packaging: Tray  
 Mates With: 98317, 98599 and 98580  
 Use With: 98658 (wire terminal) or 98194 (FFC terminal)  
 Designed In: Millimeters

### Electrical

Voltage: 14V DC  
 Current: 6.0A max.  
 Contact Resistance: 8 milliohms max.  
 Dielectric Withstanding Voltage: 1000V AC  
 Insulation Resistance: 100 Megohms min.

### Mechanical

Contact Insertion Force: 5.0N (1.12 lb) max.  
 Contact Retention to Housing (TPA inactive):  
 40.0N (9 lb) min.  
 Wire Pull-Out Force: 100N (22.5 lb) min.  
 Mating Force: 80.0N (18.0 lb) max.  
 Unmating Force: 80.0N (18.0 lb) max.  
 Durability: 20 cycles (with Gold/Tin plated terminals)

### Physical

Housing: PBT Polyester, Glass-filled, UL 94-HB

[www.molex.com/mox.html](http://www.molex.com/mox.html)

# 2.54mm (.100") Pitch MOST Receptacle Housing

**98684**

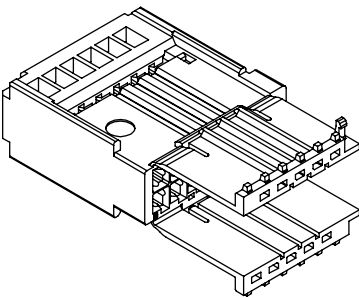

### Features and Benefits

- TPA integrated by film hinge function
- Fits into 98681-1001 and 98681-1002
- Keying prevents wrong insertion into housing frame
- Terminal cavities designed for Molex MOX 0.64mm (.025") terminals
- Conforms to USCAR-2 Rev. 3

### Reference Information

Product Specification: PS-98681-001  
 Packaging: Box  
 Mates With: 91500, 91547, 98681  
 Use With: 98658

### Electrical

Voltage: 9 to 16V DC (operating normal)  
 Current: 7.5A max.  
 Contact Resistance: 100 milliohms max.

### Mechanical

Contact Insertion Force: 30.00N (6.74 lb)  
 Contact Retention to Housing: 60.00N (13.49 lb)  
 Mating Force: 75.00N (16.86 lb)  
 Unmating Force: 75.00N (16.86 lb)  
 Durability: 11 mating cycles

### Physical

Housing: PBT Polyester, UL 94-HB

Circuits	Order No.	Color Coding	Key	Lead-free
12	<a href="#">98684-0001</a>	Black	Key A	Yes
	<a href="#">98684-0002</a>	Natural	Key B	

## 2.54mm (.100") Pitch MOST Junction Box

**91616**

**Vertical, without 10.0A Fuse**

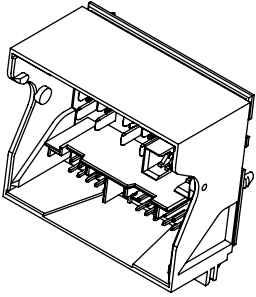

Circuits	Order No.	Lead-free
40	<a href="#">91616-0001</a>	Yes

### Features and Benefits

- Complies with MOST specifications and is therefore a drop-in replacement part
- Fuse options available
- Mini-PCB assembly available
- Lead-free

### Reference Information

Product Specification: PS-91616-001  
Packaging: Tray  
Designed In: Millimeters

### Electrical

Voltage: 16V  
Current: 6.0A  
Contact Resistance: 10 milliohms max.  
Dielectric Withstanding Voltage: 500V AC  
Insulation Resistance: 500 Megohms min.

### Mechanical

Insertion Force to PCB: 70.0N (15.74 lb)  
Durability: 30 cycles

### Physical

Housing: Glass-filled PA Polyamide (nylon), UL 94V-0  
Contact: Copper Alloy  
Plating: Contact Area—Tin  
PCB Thickness: 1.6mm (0.62")

## 5.08mm (.200") Pitch MOST Frame Receptacle Housing

**98681**

**With Lever,  
40 Electrical and 4 Optical Circuits  
(Optional)**

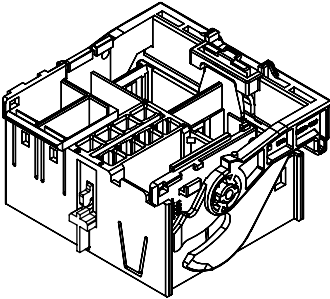

Order No.		Lead-free
With Cable Cover	Without Cable Cover	
<a href="#">98681-1001</a>	<a href="#">98681-1002</a>	Yes

### Features and Benefits

- MOST corporation interface
- Plastic optical fiber option integrated
- Version with feature to receive wire cap/strain relief 98660-0001
- Conforms to USCAR-2 Rev. 3 and Ford SDS Rev. 10

### Reference Information

Product Specification: PS-98681-001  
Packaging: Box  
Mates With: 91616, 91574  
Use With: 98660, 98684, 98685  
Designed In: Millimeters

### Electrical

Voltage: 9 to 16V DC (operating normal)  
Current: 24.0A max.  
Contact Resistance: 5 milliohms max.

### Mechanical

Contact Insertion Force: <30.00N (6.74 lb)  
Contact Retention to Housing: >60.00N (13.49 lb)  
Mating Force: 75.00N (16.86 lb)  
Unmating Force: 75.00N (16.86 lb)  
Durability: 11 mating cycles

### Physical

Housing: Black glass-filled SPS/PA 6/6, UL 94-HB

# 5.08mm (.200") Pitch MOST Receptacle Power Connector

**98685**  
With TPA Lock

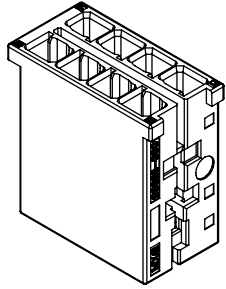

Circuits	Order No.	Lead-free
8	<a href="#">98685-1001</a>	Yes

### Features and Benefits

- Fits to MOST frame receptacle housing 98681-1001 and 98681-1002
- Delivered with Terminal Position Assurances (TPA) in pre-lock position
- Conforms to USCAR-2 Rev. 3 and Ford SDS Rev. 10

### Reference Information

Product Specification: PS-98681-001  
Packaging: Box  
Mates With: 91500, 91547 and 98681  
Use With: 2.80mm (.110") MPQ terminals

### Electrical

Voltage: 9 to 16V DC (operating normal)  
Current: 24.0A max.  
Contact Resistance: 5 milliohms max.

### Mechanical

Contact Insertion Force: 30.00N (6.74 lb) min.  
Contact Retention to Housing: 60.00N (13.49 lb) max.  
Mating Force: 75.00N (16.86 lb)  
Unmating Force: 75.00N (16.86 lb)

### Physical

Housing: Black glass-filled SPS Crystalline Polymer, UL 94-HB

# 5.08mm (.200") Pitch MOST Strain Relief Cable Cover

**98660**

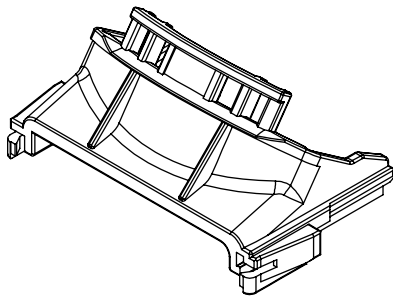

Order No.	Lead-free
<a href="#">98660-0001</a>	Yes

### Features and Benefits

- Provides 45° wire
- Positive clip
- Conforms to USCAR-2 Rev. 3 and Ford SDS Rev. 10

### Reference Information

Product Specification: PS-98681-001  
Packaging: Bag  
Use With: 98681-1001

### Physical

Housing: Black PBT Polyester

# 3.33mm (.131")/ 6.00mm (.236") Pitch NSCC Hybrid Inline Receptacle Housing

**98273**  
Dual Row, Vertical with Slide

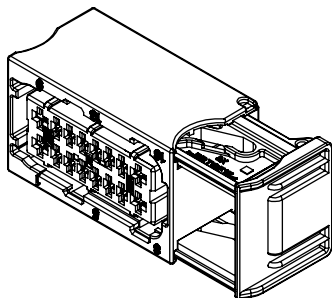

### Features and Benefits

- Secondary locking for 1.54 and 2.8mm (.060 and .110") terminals
- Slide to reduce mating force
- Right slide orientation
- Hole feature to seal the slide in locked position
- Six mechanical codings correlating with 6 housing colors

### Reference Information

Packaging: Box  
Mates With: 98276  
Use With: 98897 and 98898  
Designed In: Millimeters

### Electrical

Voltage: 13.5V  
Current:  
1. 50mm—7.0A max. at 85°C crimped on 2.0mm<sup>2</sup> wire  
2. 80mm—15.0A max. at 85°C crimped on 4.0mm<sup>2</sup> wire  
Dielectric Withstanding Voltage: 1000V min.  
Insulation Resistance: 200 Megohms min.

### Mechanical

Contact Insertion Force: 1.5mm (.060")—5.0N max.  
2.8mm (.110")—8.0N max.  
Contact Retention to Housing: 1.5mm (.060")—100.0N min.  
2.8mm (.110")—100.0N min.

Mating Force: 60.0N max.  
Unmating Force: 20.0N min.  
Normal Force: 150.0N min.  
Durability: 20 cycles

### Physical

Housing: Glass-filled PBT Polyester, UL 94-HB

Circuits	Order No.	Color	Lead-free
16	<a href="#">98273-1001</a>	Black	Yes
	<a href="#">98273-1002</a>	Green	
	<a href="#">98273-1003</a>	Blue	
	<a href="#">98273-1004</a>	White	
	<a href="#">98273-1005</a>	Brown	
	<a href="#">98273-1006</a>	Gray	

# 3.33mm (.131")/ 6.00mm (.236") Pitch NSCC Hybrid Inline Plug Housing

**98276**  
Dual Row, Vertical

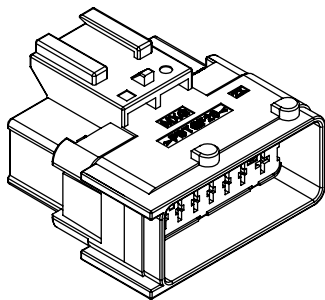

### Features and Benefits

- Secondary locking for 1.5 and 2.8mm (.060 and .110") terminals
- Six mechanical codings correlating with 6 housing colors
- Clip feature for standard fir tree clip

### Reference Information

Packaging: Box  
Mates With: 98273  
Use With: 1.5 and 2.8mm blade terminals  
Designed In: Millimeters

### Electrical

Voltage: 13.5V  
Dielectric Withstanding Voltage: 1000V min.  
Insulation Resistance: 200 Megohms min.

### Mechanical

Contact Insertion Force: 1.5mm (.060")—5.0N max.  
2.8mm (.110")—8.0N max.  
Contact Retention to Housing: 1.5mm (.060")—100.0N min.  
2.8mm (.110")—100.0N min.

Mating Force: 60.0N max.  
Unmating Force: 20.0N min.  
Normal Force: 150N min.  
Durability: 20 cycles

### Physical

Housing: Glass-filled PBT Polyester, UL 94-HB

Circuits	Order No.	Color	Lead-free
16	<a href="#">98276-1001</a>	Black	Yes
	<a href="#">98276-1002</a>	Green	
	<a href="#">98276-1003</a>	Blue	
	<a href="#">98276-1004</a>	White	
	<a href="#">98276-1005</a>	Brown	
	<a href="#">98276-1006</a>	Gray	

# 5.00mm (.197") Pitch NSSC Wire-to-Board Receptacle Housing

**98438**

**Vertical, with Bridges  
For 2.80mm (.110") Tab**

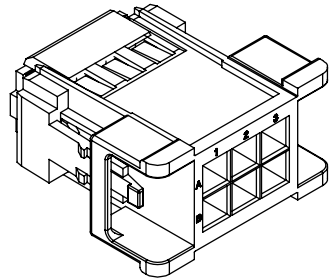

### Features and Benefits

- Designed for 2.80mm (.110") terminals from Molex
- Secondary locking
- Six mechanical codings available
- Two bridges to avoid damaging of latches
- Unsealed connector system

### Reference Information

Packaging: Box  
Mates With: Any 2.80mm (.110") header  
Use With: 98898 2.80mm (.110") UCC terminals  
Designed In: Millimeters

### Electrical

Current: 15.0A max. @ 85°C  
Dielectric Withstanding Voltage: 1000V AC or 1400V DC  
Insulation Resistance: 100 Megohms min.

### Mechanical

Contact Insertion Force: 10.0N (2.25 lb) max.  
Contact Retention to Housing: 80.0N (17.98 lb) min.  
Mating Force: 60.0N (13.49 lb) max.  
Unmating Force: 150.0N (33.72 lb) max.

### Physical

Housing: PBT Polyester, UL 94-HB

Circuits	Order No.	Color	Lead-free
6	<a href="#">98438-1001</a>	Natural	Yes
	<a href="#">98438-1002</a>	Black	
	<a href="#">98438-1003</a>	Gray	
	<a href="#">98438-1004</a>	Blue	
	<a href="#">98438-1005</a>	Brown	
	<a href="#">98438-1006</a>	Red	

[www.molex.com](http://www.molex.com)

# 4.00mm (.157") Pitch OBD-II Wire-to-Wire Terminal

**50420**

**Female**

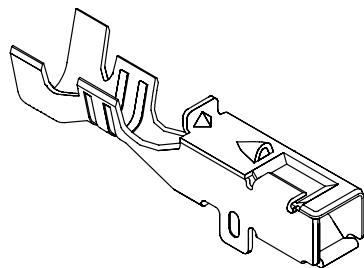

### Features and Benefits

- Two-point contact design provides a redundant electrical interface
- Accepts retainer for additional terminal retention

### Reference Information

Product Specification: PS-51115-001  
Packaging: Reel  
Mates With: 57964  
Use With: 51115 and 51116  
Designed In: Millimeters

### Electrical

Voltage: 30V

Current:

Wire Size	Current
AVS,AVSS 0.3	4A
AVS,AVSS,CAVS 0.5	5A
AVS,AVSS,CAVS 0.85	6A

Contact Resistance: 100 milliohms max.  
Dielectric Withstanding Voltage: 1000V AC  
Insulation Resistance: 500V DC 100 Megohms min.

### Physical

Contact: Phosphor Bronze  
Plating: Tin  
Insulation Diameter: 1.60 to 2.30mm (.024 to .091")

Order No.	Wire Range (mm <sup>2</sup> )	Lead-free
<a href="#">50420-8000</a>	AVS 0.3-0.5	Yes
	AVS 0.30F-0.75F	
	AVSS 0.50-0.85	
	AVSS 0.50F-0.75F	
	CAVS 0.50-0.85	



# 4.00mm (.157") Pitch OBD-II Wire-to-Wire Housing

## 51115 Female, Panel Mount Type

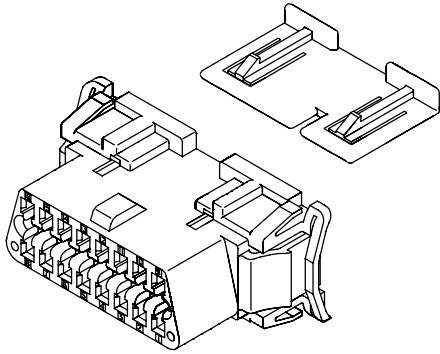

Circuits	Order No.
16	<a href="#">51115-1601</a>
	<a href="#">51115-1611</a>

### Features and Benefits

- Size 16 circuits only
- SAE J1962 standard for no board diagnostic
- Panel mount type

### Reference Information

Product Specification: PS-51115-001  
 Packaging: Bag  
 Mates With: 51117 TPA, 68503 (Housing, Cover, CPA),  
 68154 (Dummy Plug)  
 Use With: 50420  
 Designed In: Millimeters

### Electrical

Voltage: 30V  
 Current: 6.0A max.  
 Contact Resistance: 100 milliohms max.  
 Dielectric Withstanding Voltage: 1000V AC  
 Insulation Resistance: 500V DC 100 Megohms min.

### Mechanical

Contact Insertion Force: 9.8N (2.2 lb)  
 Contact Retention to Housing: 80.0N min. (with 51117)  
 Wire Pull-Out Force:

AVS 0.3	58.8N
AVS 0.5	88.2N
AVS 0.75F	107.8N
AVS 0.85	117.6N

Mating Force: 142N max.  
 Unmating Force: 88.0N max.  
 Durability: 200 cycles

### Physical

Housing: Polyester, UL 94V-0  
 TPA: Polyester

[www.molex.com/customer.html?seriesNumber=51115](http://www.molex.com/customer.html?seriesNumber=51115)

# 4.00mm (.157") Pitch OBD-II Wire-to-Wire Housing

## 51116 Female, Screw Mount Type

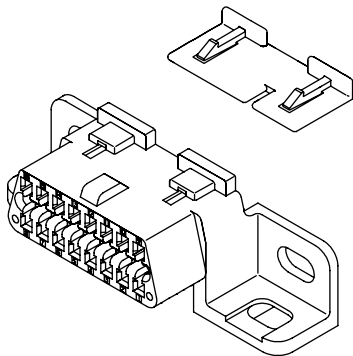

Circuits	Order No.
16	<a href="#">51116-1601</a>
	<a href="#">51116-1611</a>

### Features and Benefits

- Size 16 circuits only
- SAE J1962 standard for no board diagnostic
- Screw mount type

### Reference Information

Product Specification: PS-51115-001  
 Packaging: Bag  
 Mates With: 51118 TPA, 68503 (Housing, Cover, CPA),  
 68154 (Dummy Plug)  
 Use With: 50420  
 Designed In: Millimeters

### Electrical

Voltage: 30V  
 Current: 6.0A max.  
 Contact Resistance: 100 milliohms max.  
 Dielectric Withstanding Voltage: 1000V AC  
 Insulation Resistance: 500V DC 100 Megohms min.

### Mechanical

Contact Insertion Force: 9.8N (2.2 lb)  
 Contact Retention to Housing: 80.0N min. (with 51117)  
 Wire Pull-Out Force:

AVS 0.3	58.8N
AVS 0.5	88.2N
AVS 0.75F	107.8N
AVS 0.85	117.6N

Mating Force: 142N max.  
 Unmating Force: 88.0N max.  
 Durability: 200 cycles

### Physical

Housing: Polyester, UL 94V-0  
 TPA: Polyester

# 1.50mm (.060") Pitch MX150™ Terminals

**33001/33012**  
Female  
Mat Sealed

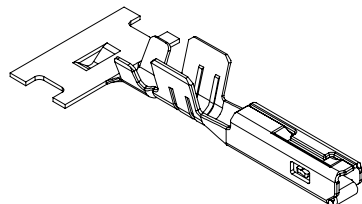

### Features and Benefits

- Meets USCAR performance testing
- Low insertion force
- Multiple plating options
- Strong crimps
- Accommodates SAE and metric wires
- Sealed and unsealed versions
- Lead free

### Reference Information

Packaging: Reel  
Use With: MX150 plastic series 33471, 33472 and 33476  
Mates With: 33012 and 33001  
Designed In: Millimeters

### Electrical

Voltage: 250V  
Current: 22.0A  
Contact Resistance: 10 milliohms max.  
Dielectric Withstanding Voltage: 500V DC  
Insulation Resistance: 20 Megohms min.

### Mechanical

Contact Insertion Force: 3.0N average  
Wire Pull-Out Force: 14 AWG—180N min.  
22 AWG—70N  
Mating Force: 3.0N average  
Unmating Force: 3.0N average  
Normal Force: 6.0N average

### Physical

Contact: Copper Alloy  
Plating: Tin, Gold or Silver  
Wire Gauge: 14 to 22 AWG (max. O.D. = 2.49mm)

Order No.		Plating	Wire Gauge
Right Payoff, B Wound	Left Payoff, D Wound		
<a href="#">33012-2001</a>	<a href="#">33012-3001</a>	Tin	14 to 16 AWG
<a href="#">33012-2002</a>	<a href="#">33012-3002</a>		18 to 20 AWG
<a href="#">33012-2003</a>	<a href="#">33012-3003</a>		22 AWG
<a href="#">33001-2003</a>	<a href="#">33001-3003</a>	Gold	14 to 16 AWG
<a href="#">33001-2004</a>	<a href="#">33001-3004</a>		18 to 20 AWG
<a href="#">33001-2005</a>	<a href="#">33001-3005</a>		22 AWG
<a href="#">33001-4001</a>	<a href="#">33001-5001</a>	Silver	14 to 16 AWG
<a href="#">33001-4002</a>	<a href="#">33001-5002</a>		18 to 20 AWG
<a href="#">33001-4003</a>	<a href="#">33001-5003</a>		22 AWG

# 1.50mm (.060") Pitch MX150™ Terminals

**34081/34083**  
Female  
Cable Sealed

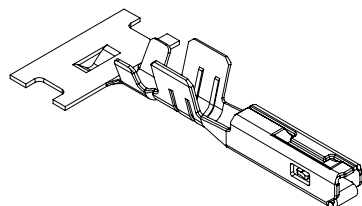

### Features and Benefits

- Meets USCAR performance testing
- Low insertion force
- Multiple plating options
- Strong crimps
- Accommodates SAE and metric wires
- Sealed and unsealed versions
- Lead free

### Reference Information

Packaging: Reel  
Use With: MX150 plastic series 34250 and 34062  
Mates With: 34080  
Designed In: Millimeters

### Electrical

Voltage: 250V  
Current: 22.0A  
Contact Resistance: 10 milliohms max.  
Dielectric Withstanding Voltage: 500V DC  
Insulation Resistance: 20 Megohms min.

### Mechanical

Contact Insertion Force: 3.0N average  
Wire Pull-Out Force: 14 AWG—180N min.  
22 AWG—70N  
Mating Force: 3.0N average  
Unmating Force: 3.0N average  
Normal Force: 6.0N average

### Physical

Contact: Copper Alloy  
Plating: Tin, Gold or Silver  
Wire Gauge: 14 to 22 AWG (max. O.D. = 2.49mm)

Order No.		Plating	Wire Gauge
Right Payoff, B Wound	Left Payoff, D Wound		
<a href="#">34083-2001</a>	<a href="#">34083-3001</a>	Tin	14 to 16 AWG
<a href="#">34083-2002</a>	<a href="#">34083-3002</a>		18 to 20 AWG
<a href="#">34083-2003</a>	<a href="#">34083-3003</a>		22 AWG
<a href="#">34081-2003</a>	<a href="#">34081-3003</a>	Gold	14 to 16 AWG
<a href="#">34081-2004</a>	<a href="#">34081-3004</a>		18 to 20 AWG
<a href="#">34081-2005</a>	<a href="#">34081-3005</a>		22 AWG
<a href="#">34081-4001</a>	<a href="#">34081-5001</a>	Silver	14 to 16 AWG
<a href="#">34081-4002</a>	<a href="#">34081-5002</a>		18 to 20 AWG
<a href="#">34081-4003</a>	<a href="#">34081-5003</a>		22 AWG

# 1.50mm (.060") Pitch MX150™ Terminals

**33000/33011**  
**Male**  
**Mat Sealed**

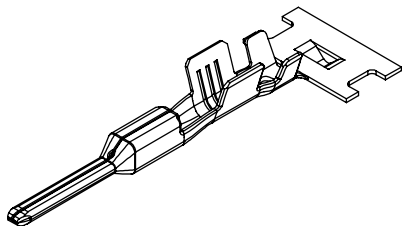

### Features and Benefits

- Meets USCAR performance testing
- Low insertion force
- Multiple plating options
- Strong crimps
- Accommodates SAE and metric wires
- Lead free

### Reference Information

Packaging: Reel  
Use With: MX150 plastic series 33471, 33472 and 33476  
Mates With: 33012 and 33001  
Designed In: Millimeters

### Electrical

Voltage: 250V  
Current: 22.0A  
Contact Resistance: 10 milliohms max.  
Dielectric Withstanding Voltage: 500V DC  
Insulation Resistance: 20 Megohms min.

### Mechanical

Contact Insertion Force: 3.0N average  
Wire Pull-Out Force: 14 AWG—180N min.  
22 AWG—70N  
Mating Force: 3.0N average  
Unmating Force: 3.0N average  
Normal Force: 6.0N average

### Physical

Contact: Copper Alloy  
Plating: Tin, Gold or Silver  
Wire Gauge: 14 to 22 AWG (max. O.D. = 2.49mm)

Order No.		Plating	Wire Gauge
Right Payoff, B Wound	Left Payoff, D Wound		
<a href="#">33000-0001</a>	<a href="#">33000-1001</a>	Tin	14 AWG
<a href="#">33000-0002</a>	<a href="#">33000-1002</a>		16 to 20 AWG
<a href="#">33000-0003</a>	<a href="#">33000-1003</a>		22 AWG
<a href="#">33011-1002</a>	<a href="#">33011-0002</a>	Gold	14 AWG
<a href="#">33011-1004</a>	<a href="#">33011-0004</a>		16 to 20 AWG
<a href="#">33011-1006</a>	<a href="#">33011-0006</a>		22 AWG
<a href="#">33011-2001</a>	<a href="#">33011-3001</a>	Silver	14 AWG
<a href="#">33011-2002</a>	<a href="#">33011-3002</a>		16 to 20 AWG
<a href="#">33011-2003</a>	<a href="#">33011-3003</a>		22 AWG

# 1.50mm (.060") Pitch MX150™ Terminals

**34080**  
**Male**  
**Cable Sealed**

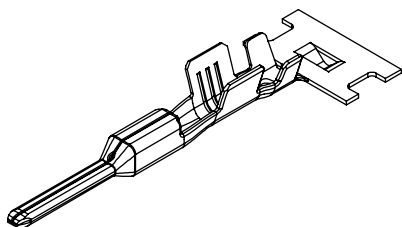

### Features and Benefits

- Meets USCAR performance testing
- Low insertion force
- Multiple plating options
- Strong crimps
- Accommodates SAE and metric wires
- Lead free

### Reference Information

Packaging: Reel  
Use With: MX150 plastic series 34091 and 34615  
Mates With: 34083  
Designed In: Millimeters

### Electrical

Voltage: 250V  
Current: 22.0A  
Contact Resistance: 10 milliohms max.  
Dielectric Withstanding Voltage: 500V DC  
Insulation Resistance: 20 Megohms min.

### Mechanical

Contact Insertion Force: 3.0N average  
Wire Pull-Out Force: 14 AWG—180N min.  
22 AWG—70N  
Mating Force: 3.0N average  
Unmating Force: 3.0N average  
Normal Force: 6.0N average

### Physical

Contact: Copper Alloy  
Plating: Tin  
Wire Gauge: 14 to 22 AWG (max. O.D. = 2.49mm)

Order No.		Plating	Wire Gauge
Right Payoff, B Wound	Left Payoff, D Wound		
<a href="#">34080-0001</a>	<a href="#">34080-1001</a>	Tin	14 to 16 AWG
<a href="#">34080-0002</a>	<a href="#">34080-1002</a>		18 to 20 AWG
<a href="#">34080-0003</a>	<a href="#">34080-1003</a>		22 AWG

# 3.50mm (.138") Pitch MX150™ Sealed Connectors

**33471 Female**  
**33481 Male**  
**Single Row**

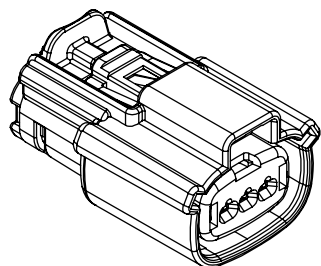

### Features and Benefits

- Meets USCAR performance requirements
- Smallest 1.50mm (.059") sealed connector in the market
- Terminal retention is 2x industry standard
- Matte seal design
- Polarization options available
- Available with or without CPA
- Clip slot standard on male side

### Reference Information

Packaging: Bulk  
Mates With: 33471 and 33481  
Use With: MX150 terminals  
Designed In: Millimeters

### Electrical

Voltage: 250V  
Current: 22.0A  
Contact Resistance: 20 milliohms max.  
Dielectric Withstanding Voltage: 500V DC  
Insulation Resistance: 20 Megohms min.

### Mechanical

Contact Insertion Force: Less than 15N  
Contact Retention to Housing: 110N min.  
Wire Pull-Out Force: 90N min.  
Mating Force: 75N max.  
Unmating Force: 75N max.  
Normal Force: Terminal dependent

### Physical

Housing: 30% glass filled nylon, UL 94-HB  
Contact: Will accommodate Tin, Silver or Gold  
Insulation Diameter: 14 AWG UTX 2.49mm O.D. to  
22 AWG TXL  
Wire Gauge: 14 to 22 AWG and Metric

Circuits	Order No.	Description	Color	CPA Option
3	33471-0301	1x3 Female Polarization A	Black	No
	33471-0302	1x3 Female Polarization B	Gray	
	33471-0306	1x3 Female Polarization A	Black	Yes
	33471-0307	1x3 Female Polarization B	Gray	
	33481-0301	1x3 Male Polarization A	Black	No
	33481-0302	1x3 Male Polarization B	Gray	
4	33471-0401	1x4 Female Polarization A	Black	No
	33471-0402	1x4 Female Polarization B	Gray	
	33471-0406	1x4 Female Polarization A	Black	Yes
	33471-0407	1x4 Female Polarization B	Gray	
	33481-0401	1x4 Male Polarization A	Black	No
	33481-0402	1x4 Male Polarization B	Gray	
6	33471-0601	1x6 Female Polarization A	Black	No
	33471-0602	1x6 Female Polarization B	Gray	
	33471-0606	1x6 Female Polarization A	Black	Yes
	33471-0607	1x6 Female Polarization B	Gray	
	33481-0601	1x6 Male Polarization A	Black	No
	33481-0602	1x6 Male Polarization B	Gray	

# 3.50mm (.138") Pitch MX150™ Hybrid Sealed Connectors

**33476 Female**  
**33486 Male**  
**Dual Row**

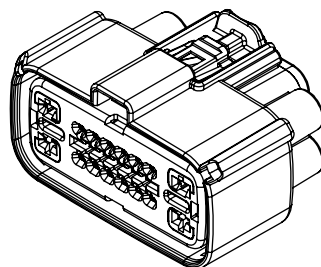

### Features and Benefits

- Combines 1.50 and 2.80mm (.059 and .110") terminals in same connector
- Terminal retention is 2x industry standard
- Polarization options available
- Available with or without CPA
- Clip slot standard on male side

### Reference Information

Packaging: Bag  
Mates with: 33471 and 33481  
Use With: MX150 terminals  
Designed In: Millimeters

### Electrical

Voltage: 250V  
Current: 22.0A for 1.5mm terminals and 25.0A for 2.8mm terminals  
Contact Resistance: 20 milliohms max.  
Dielectric Withstanding Voltage: 500V DC  
Insulation Resistance: 20 Megohms min.

### Mechanical

Contact Insertion Force: Less than 15N  
Contact Retention to Housing: 110N min.  
Wire Pull-Out Force: 90N min.  
Mating Force: 75N max.  
Unmating Force: 75N max.  
Normal Force: Terminal dependent

### Physical

Housing: 30% glass filled nylon, UL 94-HB  
*1.5mm terminals*  
Contact: Tin, Silver or Gold  
Insulation Diameter: 14 AWG UTX 2.49mm O.D. to  
22 AWG TXL  
Wire Gauge: 14 to 22 AWG and Metric  
*2.8mm terminals*  
Contacts: Tin  
Wire Gauge: 12 to 22 AWG

Order No.	Description	Color	CPA Option
33476-1601	2x8 Female Polarization A	Black	No
33476-1602	2x8 Female Polarization B	Gray	
33476-1606	2x8 Female Polarization A	Black	Yes
33476-1607	2x8 Female Polarization B	Gray	
33486-1601	2x8 Male Polarization A	Black	No
33486-1602	2x8 Male Polarization B	Gray	

# 3.50mm (.138") Pitch MX150™ Sealed Connectors

**33472 Female**  
**33482 Male**  
**Dual Row**

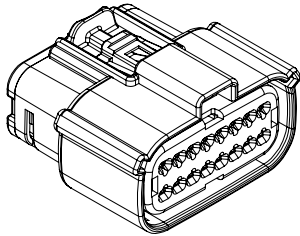

### Features and Benefits

- Meets USCAR footprint and performance requirements
- Smallest 1.50mm (.059") sealed connector in the market
- Terminal retention is 2x industry standard
- Matte seal design
- Polarization options available
- Available with or without CPA
- Clip slot standard on male side

### Reference Information

Packaging: Bag  
Mates With: 33471 and 33481  
Use With: MX150 terminals  
Designed In: Millimeters

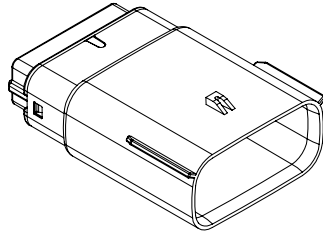

### Electrical

Voltage: 250V  
Current: 22.0A  
Contact Resistance: 20 milliohms max.  
Dielectric Withstanding Voltage: 500V DC  
Insulation Resistance: 20 Megohms min.

### Mechanical

Contact Insertion Force: Less than 15N  
Contact Retention to Housing: 110N min.  
Wire Pull-Out Force: 90N min.  
Mating Force: 75N max.  
Unmating Force: 75N max.  
Normal Force: Terminal dependent

### Physical

Housing: 30% glass filled nylon, UL 94-HB  
Contact: Will accommodate Tin, Silver or Gold  
Insulation Diameter: 14 AWG UTX 2.49mm O.D. to 22 AWG TXL  
Wire Gauge: 14 to 22 AWG and Metric

Circuits	Order No.	Description	Color	CPA Option	
4	<a href="#">33472-0401</a>	2x2 Female Polarization A	Black	No	
	<a href="#">33472-0402</a>	2x2 Female Polarization B	Gray		
	<a href="#">33472-0406</a>	2x2 Female Polarization A	Black	Yes	
	<a href="#">33472-0407</a>	2x2 Female Polarization B	Gray		
	<a href="#">33482-0401</a>	2x2 Male Polarization A	Black	No	
	<a href="#">33482-0402</a>	2x2 Male Polarization B	Gray		
6	<a href="#">33472-0601</a>	2x3 Female Polarization A	Black	No	
	<a href="#">33472-0602</a>	2x3 Female Polarization B	Gray		
	<a href="#">33472-0606</a>	2x3 Female Polarization A	Black	Yes	
	<a href="#">33472-0607</a>	2x3 Female Polarization B	Gray		
	<a href="#">33482-0601</a>	2x3 Male Polarization A	Black	No	
	<a href="#">33482-0602</a>	2x3 Male Polarization B	Gray		
8	<a href="#">33472-0801</a>	2x4 Female Polarization A	Black	No	
	<a href="#">33472-0802</a>	2x4 Female Polarization B	Gray		
	<a href="#">33472-0806</a>	2x4 Female Polarization A	Black	Yes	
	<a href="#">33472-0807</a>	2x4 Female Polarization B	Gray		
	<a href="#">33482-0801</a>	2x4 Male Polarization A	Black	No	
	<a href="#">33482-0802</a>	2x4 Male Polarization B	Gray		
12	<a href="#">33472-1201</a>	2x6 Female Polarization A	Black	No	
	<a href="#">33472-1202</a>	2x6 Female Polarization B	Gray		
	<a href="#">33472-1206</a>	2x6 Female Polarization A	Black	Yes	
	<a href="#">33472-1207</a>	2x6 Female Polarization B	Gray		
	<a href="#">33482-1201</a>	2x6 Male Polarization A	Black	No	
	<a href="#">33482-1202</a>	2x6 Male Polarization B	Gray		
	16	<a href="#">33472-1601</a>	2x8 Female Polarization A	Black	No
		<a href="#">33472-1602</a>	2x8 Female Polarization B	Gray	
		<a href="#">33472-1606</a>	2x8 Female Polarization A	Black	Yes
		<a href="#">33472-1607</a>	2x8 Female Polarization B	Gray	
		<a href="#">33482-1601</a>	2x8 Male Polarization A	Black	No
		<a href="#">33482-1602</a>	2x8 Male Polarization B	Gray	
20	<a href="#">33472-2001</a>	2x10 Female Polarization A	Black	No	
	<a href="#">33472-2002</a>	2x10 Female Polarization B	Gray		
	<a href="#">33472-2006</a>	2x10 Female Polarization A	Black	Yes	
	<a href="#">33472-2007</a>	2x10 Female Polarization B	Gray		
	<a href="#">33482-2001</a>	2x10 Male Polarization A	Black	No	
	<a href="#">33482-2002</a>	2x10 Male Polarization B	Gray		

# 5.00mm (.197") Pitch MX150™ Cable Sealed Connectors

**34675**  
**Male**  
**Single Row**

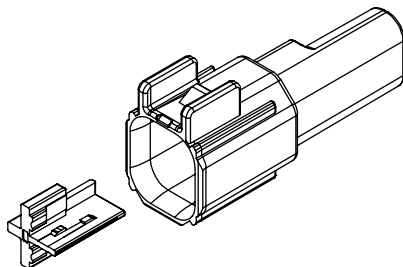

### Features and Benefits

- Compact 1.50mm (.059") terminal connector
- Glass-filled thermoplastic housing and pre-loaded terminal position assurance (TPA)
- Optional clip slot
- Audible and tactile clicks on insertion, extraction and mating
- Accommodates up to 14AWG wire

### Reference Information

Product Specification: PS-34062-000  
Packaging: Bag  
Mates With: 34062 female receptacle  
Use With: 34080 male terminals  
Designed In: Millimeters

### Electrical

Voltage: 500V  
Current: 22.0A  
Contact Resistance: 10 milliohms max.  
Dielectric Withstanding Voltage: 1500V AC  
Insulation Resistance: 20 Megohms min.

### Mechanical

Contact Insertion Force: 30N (6.7 lb) max.  
Contact Retention to Housing: 90N (20.2 lb) min.  
Mating Force: 45N (10.1 lb)  
Unmating Force: 45N (10.1 lb)  
Durability: 10 cycles

### Physical

Housing: Nylon 6, 30% glass filled

Circuits	Order No.	Clip Slot	Lead-free
2	<a href="#">34675-0001</a>	No	Yes
	<a href="#">34675-0002</a>		
	<a href="#">34675-0003</a>	Yes	
	<a href="#">34675-0004</a>		

# 4.50mm (.177") Pitch MX150™ Cable Sealed Connector

**34250**  
Single Row

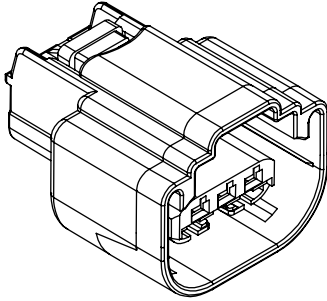

### Features and Benefits

- Compact 1.50mm (.059") terminal connector
- Meets USCAR footprints
- Uses cable sealed terminals
- Available with or without CPA
- Polarization options available
- Single and dual key options

### Reference Information

Packaging: Bag  
Mates With: Direct connect only  
Designed In: Millimeters

### Electrical

Voltage: 250V  
Current: 15.0A  
Contact Resistance: 20 milliohms max.  
Dielectric Withstanding Voltage: 500V DC  
Insulation Resistance: 20 Megohms min.

### Mechanical

Contact Insertion Force: Less than 15N  
Contact Retention to Housing: 100N min.  
Wire Pull-Out Force: 90N min.  
Mating Force: Less than 45N  
Unmating Force: Less than 45N  
Normal Force: Terminal dependent

### Physical

Housing: PBT + 10% glass filled, UL 94-HB  
Contact: Tin or Gold  
Wire Gauge: 16 to 22 AWG

Order No.	Description	Color	CPA
<a href="#">34250-0001</a>	1x3 Dual Key Polarization A	Black	Yes
<a href="#">34250-0002</a>	1x3 Dual Key Polarization B	Gray	
<a href="#">34250-0003</a>	1x3 Dual Key Polarization C	Brown	
<a href="#">34250-0004</a>	1x3 Dual Key Polarization D	Green	No
<a href="#">34250-0017</a>	1x3 Dual Key Polarization A	Black	
<a href="#">34250-0018</a>	1x3 Dual Key Polarization B	Gray	
<a href="#">34250-0019</a>	1x3 Dual Key Polarization C	Brown	
<a href="#">34250-0020</a>	1x3 Dual Key Polarization D	Green	Yes
<a href="#">34250-0033</a>	1x3 Single Key Polarization A	Black	
<a href="#">34250-0034</a>	1x3 Single Key Polarization B	Gray	
<a href="#">34250-0035</a>	1x3 Single Key Polarization C	Brown	
<a href="#">34250-0036</a>	1x3 Single Key Polarization D	Green	No
<a href="#">34250-0049</a>	1x3 Single Key Polarization A	Black	
<a href="#">34250-0050</a>	1x3 Single Key Polarization B	Gray	
<a href="#">34250-0051</a>	1x3 Single Key Polarization C	Brown	
<a href="#">34250-0052</a>	1x3 Single Key Polarization D	Green	

# 5.00mm (.197") Pitch MX150™ Cable Sealed Connector

**34062**  
Single Row

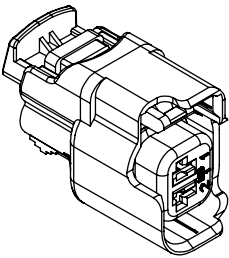

### Features and Benefits

- Compact 1.50mm (.059") terminal connector
- Meets USCAR footprints
- Uses cable sealed terminals
- Available with or without CPA
- Polarization options available

### Reference Information

Packaging: Bag  
Mates With: Direct connect only  
Designed In: Millimeters

### Electrical

Voltage: 250V  
Current: 15.0A  
Contact Resistance: 20 milliohms max.  
Dielectric Withstanding Voltage: 500V DC  
Insulation Resistance: 20 Megohms min.

### Mechanical

Contact Insertion Force: Less than 15N  
Contact Retention to Housing: 100N min.  
Wire Pull-Out Force: 90N min.  
Mating Force: Less than 45N  
Unmating Force: Less than 45N  
Normal Force: Terminal dependent

### Physical

Housing: PBT + 10% glass filled, UL 94-HB  
Contact: Tin or Gold  
Wire Gauge: 16 to 22AWG

Order No.	Description	Color	CPA
<a href="#">34062-0001</a>	1x2 Polarization A	Black	No
<a href="#">34062-0002</a>	1x2 Polarization B	Gray	
<a href="#">34062-0003</a>	1x2 Polarization C	Black	
<a href="#">34062-0004</a>	1x2 Polarization D		
<a href="#">34062-0005</a>	1x2 Polarization A	Black	Yes
<a href="#">34062-0006</a>	1x2 Polarization B	Gray	
<a href="#">34062-0007</a>	1x2 Polarization C	Black	
<a href="#">34062-0008</a>	1x2 Polarization D		
<a href="#">34062-0009</a>	1x2 Polarization D	Gray	No
<a href="#">34062-0010</a>	1x2 Polarization D	Gray	Yes

## 2.50mm (.098") Pitch Splash Proof Wire-to-Wire Crimp Terminal

**50148**

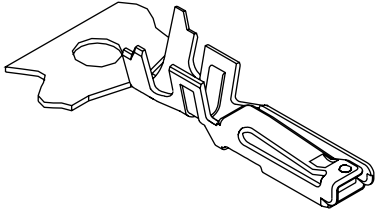

Order No.	Packaging	Lead-free
<a href="#">50148-8000</a>	Reel	Yes
<a href="#">50148-8100</a>	Bag	

### Features and Benefits

- Unique spring-beam design provides high pressure and small deflection for high vibration applications
- Stabilizing bump at tip keeps terminal in place during mating

### Reference Information

Packaging: Reel or bag  
Use With: 52213  
Designed In: Millimeters

### Electrical

Voltage: 18V max. (2 circuits)  
25V max. (3-4 circuits)  
Current: AVSS/CAVS 0.50 sq. (20 AWG)—4.0A  
AVSS/CAVS 0.30 sq. (22 AWG)—3.0A

### Physical

Contact: Phosphor Bronze  
Plating: Tin  
Wire Range: AVSS/CAVS 0.30 sq., 0.50 sq. (20 to 22 AWG)  
Insulation Range: 1.40 to 1.70mm  
Strip Length: 2.00 to 2.50mm

## 2.50mm (.098") Pitch Splash Proof Wire-to-Wire Crimp Terminal

**50147**

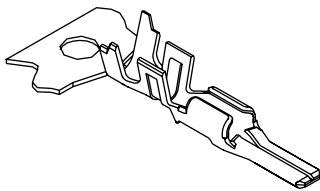

Order No.	Packaging	Lead-free
<a href="#">50147-8000</a>	Reel	Yes
<a href="#">50147-8100</a>	Bag	

### Features and Benefits

- Seal is in housing to simplify crimping process
- Raised split-beam design provides polarization

### Reference Information

Packaging: Reel or bag  
Use With: 52266  
Designed In: Millimeters

### Electrical

Voltage: 18V max. (2 circuits)  
25V max. (3-4 circuits)  
Current: AVSS/CAVS 0.50 sq. (20 AWG)—4.0A  
AVSS/CAVS 0.30 sq. (22 AWG)—3.0A

### Physical

Contact: Phosphor Bronze  
Plating: Tin  
Wire Range: AVSS/CAVS 0.30 sq., 0.50 sq. (20 to 22 AWG)  
Insulation Range: 1.40 to 1.70mm  
Strip Length: 2.00 to 2.50mm



# 2.50mm (.098") Pitch Splash Proof Wire-to-Wire Receptacle

**52213**  
**2-Circuit Version**

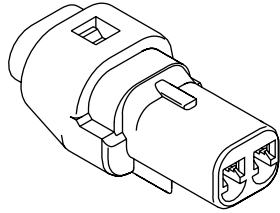

Circuits	Order No.
2	<a href="#">52213-0211</a>

### Features and Benefits

- Size 2 circuits
- JIS D0203 S2 waterproof compliant
- Unique seal stopper design provides low insertion force
- For tight packaging applications
- User-friendly friction lock saves space and protects locking latch area
- Polarizing rib to ensure proper mating

### Reference Information

Product Specification: PS-52213-001  
Packaging: Tray  
Mates With: 52266  
Use With: 50148  
Designed In: Millimeters

### Electrical

Voltage: 18V max.  
Current: 4.0A max.  
Contact Resistance: 10 milliohms max.  
Dielectric Withstanding Voltage: 500V AC/1 min.  
Insulation Resistance: 250 Megohms min.

### Physical

Housing: Black glass-filled PBT  
Cap: Glass-filled PBT  
Wire End Seal: Silicone

# 2.50mm (.098") Pitch Splash Proof Wire-to-Wire Receptacle

**52213**  
**3 and 4-Circuit Version**

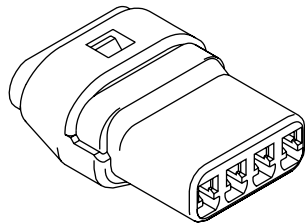

Circuits	Order No.	Housing/Cap Color
3	<a href="#">52213-0311</a>	Black
4	<a href="#">52213-0417</a>	Brown

### Features and Benefits

- Sizes 3 and 4 circuits
- JIS D0203 S2 waterproof compliant
- Unique seal stopper design provides low insertion force
- For tight packaging applications
- User-friendly friction lock saves space and protects locking latch area
- One-body wire and seal enables tighter spacing between terminals

### Reference Information

Product Specification: PS-52213-002  
Packaging: Tray  
Mates With: 52266  
Use With: 50148  
Designed In: Millimeters

### Electrical

Voltage: 25V max.  
Current: 4.0A max.  
Contact Resistance: 10 milliohms max.  
Dielectric Withstanding Voltage: 500V AC/1 min.  
Insulation Resistance: 250 Megohms min.

### Physical

Housing/Cap: Glass-filled PBT  
Wire End Seal: Silicone

## 2.50mm (.098") Pitch Splash Proof Wire-to-Wire Plug

### 52266 2-Circuit Version

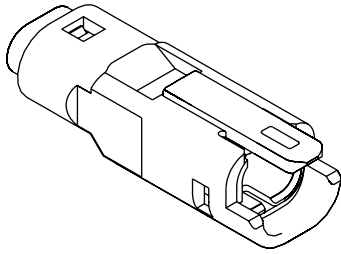

Circuits	Order No.
2	<a href="#">52266-0211</a>

#### Features and Benefits

- Size 2 circuits
- JIS D0203 S2 waterproof compliant
- Unique seal stopper design provides low insertion force
- For tight packaging applications
- User-friendly friction lock saves space and protects locking latch area
- One-body wire and seal enables tighter spacing between terminals

#### Reference Information

Product Specification: PS-52213-001  
Packaging: Tray  
Mates With: 52213  
Use With: 50147  
Designed In: Millimeters

#### Electrical

Voltage: 18V max.  
Current: 4.0A max.  
Contact Resistance: 10 milliohms max.  
Dielectric Withstanding Voltage: 500V AC/1 min.  
Insulation Resistance: 250 Megohms min.

#### Physical

Housing: Black glass-filled PBT  
Cap: Glass-filled PBT  
Wire End Seal: Silicone  
Seal Stopper: Glass-filled PBT  
Seal: Silicone

## 2.50mm (.098") Pitch Splash Proof Wire-to-Wire Plug

### 52266 3 and 4-Circuit Version

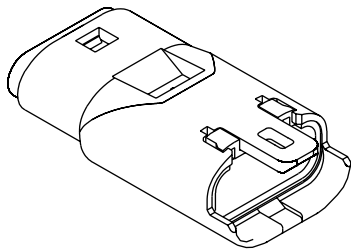

Circuits	Order No.	Housing/Cap Color
3	<a href="#">52266-0311</a>	Black
4	<a href="#">52266-0417</a>	Brown

#### Features and Benefits

- Sizes 3 and 4 circuits
- JIS D0203 S2 waterproof compliant
- Unique seal stopper design provides low insertion force
- For tight packaging applications
- User-friendly friction lock saves space and protects locking latch area
- One-body wire and seal enables tighter spacing between terminals

#### Reference Information

Product Specification: PS-52213-002  
Packaging: Tray  
Mates With: 52213  
Use With: 50147  
Designed In: Millimeters

#### Electrical

Voltage: 25V max.  
Current: 4.0A max.  
Contact Resistance: 10 milliohms max.  
Dielectric Withstanding Voltage: 500V AC/1 min.  
Insulation Resistance: 250 Megohms min.

#### Physical

Housing/Cap: Glass-filled PBT  
Wire End Seal: Silicone  
Seal Stopper: Glass-filled PBT  
Seal: Silicone

## 2.50mm (.098") Pitch Splash Proof Wire-to-Wire Crimp Terminal

**50039**

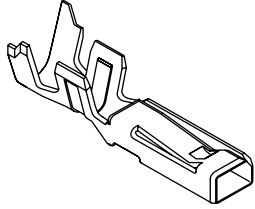

Order No.	Packaging	Lead-free
<a href="#">50039-8000</a>	Reel	Yes
<a href="#">50039-8100</a>	Bag	

### Features and Benefits

- Unique spring-beam design provides high pressure and small deflection for high vibration applications

### Reference Information

Packaging: Reel or Bag  
Use With: 52117  
Designed In: Millimeters

### Electrical

Voltage: 250V  
Current: 3.0A

### Physical

Contact: Phosphor Bronze  
Plating: Tin  
Wire Range: AVS 0.30 sq., CAVS 0.50 sq. (20 to 22 AWG)  
Insulation Range: 1.80 to 1.90mm  
Strip Length: 2.00 to 2.50mm

## 2.50mm (.098") Pitch Splash Proof Wire-to-Wire Crimp Terminal

**50038**

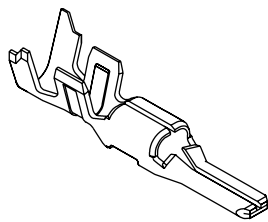

Order No.	Packaging	Lead-free
<a href="#">50038-8000</a>	Reel	Yes
<a href="#">50038-8100</a>	Bag	

### Features and Benefits

- Seal is in housing to simplify crimping process
- Raised body design provides polarization

### Reference Information

Packaging: Reel or Bag  
Use With: 52116  
Designed In: Millimeters

### Electrical

Voltage: 250V max.  
Current: 3.0A max.

### Physical

Contact: Phosphor Bronze  
Plating: Tin  
Wire Range: AVS 0.30 sq., CAVS 0.50 sq. (20 to 22 AWG)  
Insulation Range: 1.80 to 1.90mm  
Strip Length: 2.00 to 2.50mm

# 2.50mm (.098") Pitch Splash Proof Wire-to-Wire Receptacle Housing

52117

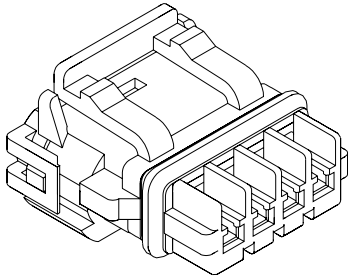

Circuits	Order No.
2	52117-024X
3	52117-034X
4	52117-041X

Note: Replace X with  
 0 = White color  
 1 = Black color  
 2 = Red color (available in 2 and 3 circuits only)

### Features and Benefits

- Sizes 2 to 4 circuits
- JIS D0203 S2 compliant
- User friendly friction lock provides secure connection

### Reference Information

Product Specification: PS-52117-001 (2 circuits)  
 PS-52117-003 (3 circuits)  
 PS-52117-005 (4 circuits)

Packaging: Tray  
 Mates With: 52116 housing  
 Use With: 50039 terminal  
 Designed In: Millimeters

### Electrical

Voltage: 250V max.  
 Current: 3.0A max.  
 Contact Resistance: 10 milliohms max.  
 Dielectric Withstanding Voltage: 500V AC/1 min.  
 Insulation Resistance: 250 Megohms min.

### Physical

Housing: Glass-filled PBT  
 Cap: Glass-filled PBT  
 Seal: Silicon

# 2.50mm (.098") Pitch Splash Proof Wire-to-Wire Plug Housing

52116

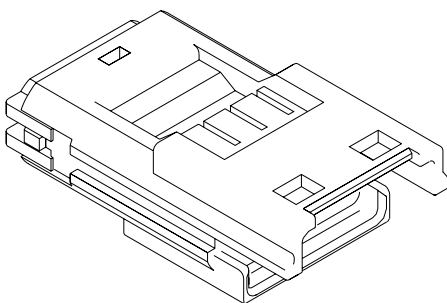

Circuits	Order No.
2	52116-024X
3	52116-034X
4	52116-041X

Note: Replace X with  
 0 = White color  
 1 = Black color  
 2 = Red color (available in 2 and 3 circuits only)

### Features and Benefits

- Sizes 2 to 4 circuits
- JIS D0203 S2 compliant
- User friendly friction lock provides secure connection

### Reference Information

Product Specification: PS-52117-001 (2 circuits)  
 PS-52117-003 (3 circuits)  
 PS-52117-005 (4 circuits)

Packaging: Tray  
 Mates With: 52117 housing  
 Use With: 50038 terminal  
 Designed In: Millimeters

### Electrical

Voltage: 250V max.  
 Current: 3.0A max.  
 Contact Resistance: 10 milliohms max.  
 Dielectric Withstanding Voltage: 500V AC/1 min.  
 Insulation Resistance: 250 Megohms min.

### Physical

Housing: Glass-filled PBT  
 Cap: Glass-filled PBT  
 Seal: Silicon

# 2.54mm (.100") Pitch MX123™ Sealed Connection System 0.64mm Terminal

33467/33468

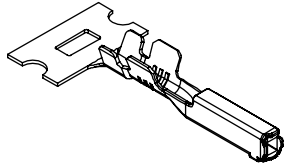

### Features and Benefits

- Precious plating ensures stable contact resistance under extreme temperature and vibration conditions

### Reference Information

Packaging: Reel  
Mates With: 73- and 80-Circuit Receptacle (Series 34566)  
56 Receptacle (Series 34576)

### Electrical

Voltage: 500V max.  
Current: 0.64mm (.025")—11.0A max.  
Contact Resistance: 0.64mm (.025")—20 milliohms max.  
Dielectric Withstanding Voltage: 1500V AC  
Isolation Resistance: 20 Megohms min.

### Mechanical

Durability—10 Cycles:  
0.64mm (.025")—20 milliohms max.  
FCLT (Class 3): 20 milliohms max.  
Thermal Shock (Class 3, 100 cycles):  
0.64mm (.025")—20 milliohms max.  
Mechanical Shock and Vibration Sequence  
(GMW3191, Electrical):  
0.64mm (.025")—20 milliohms max.

### Physical

Contact: Copper Alloy  
Terminal Plating:  
Contact Area: 0.64mm (.025")—Gold  
Underplating: 0.64mm (.025")—Nickel

Order No.	Size (mm)	Plating	Wire Size (AWG)	Payoff Direction
<a href="#">33467-0004</a>	0.64	Gold	22	D
<a href="#">33467-0003</a>				B
<a href="#">33467-0006</a>			18 to 20	D
<a href="#">33467-0005</a>				B
<a href="#">33468-0002</a>		Tin	22	D
<a href="#">33468-0001</a>				B
<a href="#">33468-0004</a>			18 to 20	D
<a href="#">33468-0003</a>				B

# 2.54mm (.100") Pitch MX123™ Sealed Connection System Cavity Plug

34586

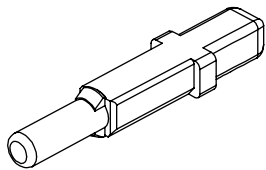

### Reference Information

Packaging: Bulk  
Use With: 73- and 80-Circuit Receptacle (Series 34566)  
56 Circuit Receptacle (Series 34576)

### Mechanical

Insertion Force: Less than 40N (9 lb)

### Physical

Material: 30% glass-filled SPS/Nylon Blend

Order No.	Assembly Features	Size (mm)
<a href="#">34586-0001</a>	Lock Tab and Forward Stop	0.64mm terminal

# 2.54mm (.100") Pitch MX123™ Sealed Connection System Lever Receptacle

34566/34576  
Mate-Assist

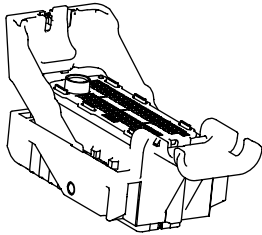

## Features and Benefits

- MX123 was originally designed for on-engine, high-vibration applications in under-hood environments
- Receptacle and header housings with unique mechanical polarization options and unique color coding offer the ability to use multiple connectors on one module without the risk of cross-mating incorrect harness connectors
- Wire dress available in 2 options: 0 and 180° orientation which allows for wire-routing design flexibility
- Anti-scooping feature is friendly to "blind-mate" conditions
- Integrated PLR and CPA components reduce assembly complexity
- Lever retention lock on harness connector retains lever in pre-lock position for ease of installation

## Reference Information

Packaging: Lever Receptacles: Cell-Pack Partition  
Mates With: 73- and 80-Circuit: Headers (Series 31387)  
56- Circuit: Header (Series 31386)  
Use With: MX64—0.64mm (.025") (Series 33467)

## Electrical

Voltage: 500V max.  
Current: 2.80mm (.110")—25.0A max.  
0.64mm (.025")—11.0A max.  
Contact Resistance: 2.80mm (.110")—5 milliohms max.  
0.64mm (.025")—20 milliohms max.  
Dielectric Withstanding Voltage: 1500V AC  
Isolation Resistance: 20 Megohms min.

## Mechanical

Mating Force: Less than 75N (16.9 lb)  
Unmating Force: Less than 75N (16.9 lb)  
Connector Retention (Primary Latch): 110N (24.7 lb) min.  
Contact Retention to Housing:  
2.80mm (.110")—90N (20.2 lb) min.  
0.64mm (.025")—75N (16.9 lb) min.  
Contact Insertion Force Into Housing: 30N (6.7 lb) max.  
Polarization Feature Effectiveness: 220N (49.5 lb) min.  
Durability—10 Cycles:  
2.80mm (.110")—5 milliohms max.  
0.64mm (.025")—20 milliohms max.  
PLR Insertion Force: 75N (16.9 lb) max.  
PLR Extraction Force: 120N (27.0 lb) max.  
CPA Insertion Force: 60N (13.5 lb) max. (unmated),  
22N (5.0 lb) max. (fully mated)  
CPA Extraction Force: 22N (5.0 lb) max.  
FCLT (Class 3): 20 milliohms max.  
Thermal Shock (Class 3, 100 cycles):  
2.80mm (.110")—5 milliohms max.  
0.64mm (.025")—20 milliohms max.  
High-Temperature Exposure (Sealing): 48kPa for 15 seconds  
and submersion for 30 minutes and isolation resistance  
of 20 Megohms at 500V DC min.  
Temperature/Humidity (Sealing): 48kPa for 15 seconds and  
submersion for 30 minutes and isolation resistance of  
20 Megohms at 500V DC min.  
Fluid Resistance (Sealing): submersion for 30 minutes and  
isolation resistance of 100 Megohms at 500V DC min.  
Mechanical Shock and Vibration Sequence  
(GMW3191, Electrical):  
2.80mm (.110")—5 milliohms max.  
0.64mm (.025")—20 milliohms max.  
Ingress Protection (IP-code) Rating: -IP6K7  
-IP6K9K

## Physical

Housing: 30% glass-filled SPS/Nylon Blend  
PLR: 30% Glass Filled SPS/Nylon Blend  
Contact: Copper Alloy  
Terminal Plating:  
Contact Area: 2.80mm (.110")—Tin  
0.64mm (.025")—Gold  
Underplating: 2.80mm (.110")—Nickel  
0.64mm (.025")—Nickel

Order No.	Circuit Size	Key Option	PLR Color
<a href="#">34566-0703</a>	80	G	Blue
<a href="#">34566-0803</a>		H	Gray
<a href="#">34566-0103</a>		A	Black
<a href="#">34566-0203</a>	73	B	Gray
<a href="#">34566-0303</a>		C	Blue
<a href="#">34576-0703</a>	56	G	Blue
<a href="#">34576-0803</a>		H	Gray

# 2.54mm (.100") Pitch MX123™ Sealed Connection System Wire Dress Cover

34565/34575

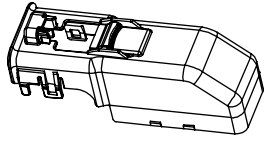

Order No.	Assembly Features	Cover for Circuit Sizes
<a href="#">34565-0003</a>	Lever Retention Lock	73 and 80
<a href="#">34575-0003</a>		56

### Features and Benefits

- Wire dress available in 2 options: 0 and 180° orientation which allows for wire-routing design flexibility

### Reference Information

Packaging: Bulk  
Use With: 73- and 80-Circuit Receptacle (Series 34566)  
56 Circuit Receptacle (Series 34576)

### Mechanical

Engage Force: Less than 75N (16.9 lb)  
Disengage Force: Less than 110N (16.9 lb)

### Physical

Material: 30% glass-filled SPS/Nylon Blend

# 2.54mm (.100") Pitch MX123™ Sealed Connection System Header

31386/31387

Vertical, Top-Load, Solder-tail

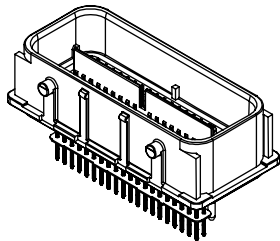

### Features and Benefits

- MX123 was originally designed for on-engine, high-vibration applications in under-hood environments
- Receptacle and header housings with unique mechanical polarization options and unique color coding offer the ability to use multiple connectors on one module without the risk of cross-mating incorrect harness connectors
- Anti-scooping feature is friendly to "blind-mate" conditions
- PCB tail customization: available with solder-tail or compliant-pin technology allows for PCB design flexibility
- Header placement flexibility allows top or bottom header loading to streamline module manufacturing process
- Precious plating ensures stable contact resistance under extreme temperature and vibration conditions

### Reference Information

Vertical Headers: Tray  
Mates With: 73- and 80-Circuit Receptacle (Series 34566)  
56 Receptacle (Series 34576)  
Use With: MX64—0.64mm (.025") (Series 33467)

### Electrical

Voltage: 500V max.  
Current: 2.80mm (.110")—25.0A max.  
0.64mm (.025")—11.0A max.  
Contact Resistance: 2.80mm (.110")—5 milliohms max.  
0.64mm (.025")—20 milliohms max.  
Dielectric Withstanding Voltage: 1500V AC  
Isolation Resistance: 20 Megohms min.

### Mechanical

Mating Force: Less than 75N (16.9 lb)  
Unmating Force: Less than 75N (16.9 lb)  
Connector Retention (Primary Latch): 110N (24.7 lb) min.  
Polarization Feature Effectiveness: 220N (49.5 lb) min.  
Durability—10 Cycles:  
2.80mm (.110")—5 milliohms max.  
0.64mm (.025")—20 milliohms max.  
FCLT (Class 3): 20 milliohms max.  
Thermal Shock (Class 3, 100 cycles):  
2.80mm (.110")—5 milliohms max.  
0.64mm (.025")—20 milliohms max.  
High-Temperature Exposure (Sealing): 48kPa for 15 seconds and submersion for 30 minutes and isolation resistance of 20 Megohms at 500V DC min.  
Temperature/Humidity (Sealing): 48kPa for 15 seconds and submersion for 30 minutes and isolation resistance of 20 Megohms at 500V DC min.  
Fluid Resistance (Sealing): submersion for 30 minutes and isolation resistance of 100 Megohms at 500V DC min.  
Mechanical Shock and Vibration Sequence (GMW3191, Electrical): 2.80mm (.110")—5 milliohms max.  
0.64mm (.025")—20 milliohms max.

### Physical

Housing: 30% glass-filled PBT  
Contact: Copper Alloy  
Terminal Plating:  
Contact Area: 2.80mm (.110")—Tin  
0.64mm (.025")—Gold  
Underplating: 2.80mm (.110")—Nickel  
0.64mm (.025")—Nickel

Order No.	Plating	Circuit Size	Key Option	Colors	
<a href="#">31387-4001</a>	Select Gold	80	G	Blue	
<a href="#">31387-4009</a>			H	Gray	
<a href="#">31387-2014</a>			A	Black	
<a href="#">31387-2002</a>			B	Gray	
<a href="#">31387-2003</a>			C		
<a href="#">31386-2001</a>			G	Blue	
<a href="#">31386-2002</a>		H	Gray		
		56			



# 2.54mm (.100") Pitch MX64™ Sealed Connectors

## 31403 Single Row Female

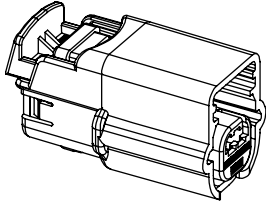

### Features and Benefits

- Meets all USCAR footprints and testing requirements
- Matte seal design
- Available with or without CPA
- Polarization options available

### Reference Information

Packaging: Bag  
Mates With: Direct connect only  
Designed In: Millimeters

### Electrical

Voltage: 250V  
Current: 11.0A max.  
Contact Resistance: 20 milliohms max.  
Dielectric Withstanding Voltage: 500V DC  
Insulation Resistance: 20 Megohms min.

### Mechanical

Contact Insertion Force: 30N max.  
Contact Retention to Housing: 90N min.  
Mating Force: Less than 75N  
Unmating Force: Less than 75N

### Physical

Housing: Glass-filled PBT  
Contact: Tin or Gold  
Wire Gauge: 18 to 22 AWG

Order No.		Rows/Circuits	Polarization	Color
Without CPA	With CPA			
<a href="#">31403-2100</a>	<a href="#">31403-2110</a>	1x2	A	Black
<a href="#">31403-2200</a>	<a href="#">31403-2210</a>		B	Gray
<a href="#">31403-2300</a>	<a href="#">31403-2310</a>		C	Brown
<a href="#">31403-2400</a>	<a href="#">31403-2410</a>		D	Green
<a href="#">31403-2500</a>	<a href="#">31403-2510</a>		B	Black
<a href="#">31403-2600</a>	<a href="#">31403-2610</a>		C	
<a href="#">31403-2700</a>	<a href="#">31403-2710</a>	D		
<a href="#">31403-3100</a>	<a href="#">31403-3110</a>	A		
<a href="#">31403-3200</a>	<a href="#">31403-3210</a>	1x3	B	Gray
<a href="#">31403-3300</a>	<a href="#">31403-3310</a>		C	Brown
<a href="#">31403-3400</a>	<a href="#">31403-3410</a>		D	Green
<a href="#">31403-3500</a>	<a href="#">31403-3510</a>		B	Black
<a href="#">31403-3600</a>	<a href="#">31403-3610</a>		C	
<a href="#">31403-3700</a>	<a href="#">31403-3710</a>		D	
<a href="#">31403-6100</a>	<a href="#">31403-6110</a>	1x6	A	
<a href="#">31403-6200</a>	<a href="#">31403-6210</a>		B	
<a href="#">31403-6300</a>	<a href="#">31403-6310</a>		C	Brown
<a href="#">31403-6400</a>	<a href="#">31403-6410</a>		D	Green
<a href="#">31403-6500</a>	<a href="#">31403-6510</a>		B	Black
<a href="#">31403-6600</a>	<a href="#">31403-6610</a>		C	
<a href="#">31403-6700</a>	<a href="#">31403-6710</a>	D		

## CMC Hybrid Connectors Standard and Power Versions

The CMC connector family from Molex is a sealed, high-density connection system developed for the transportation industry. It is a cost-effective, modular, hybrid system that fits with various headers.

Standard version CMC hybrid connectors hold two different terminal sizes, 0.635mm (.025") and 1.5mm (.059"). Power version CMC hybrid connectors hold three different terminal sizes, 0.635mm (.025"), 1.50mm (.059") and 2.80mm (.110"). Both connector versions run at operating temperatures between -40 and +125°C.

### Market and Applications

CMC can be used in the following markets: cars, trucks, buses, agricultural equipment, motorcycle or marine.

This wire-to-board application can run on Powertrain applications such as Engine Control Units, Gear Boxes and Suspension Controllers but also on Body Electronics like Junction Box, Lightning Control System or Electrical Doors.

### Features

- The CMC modular system offers various color codings associated with mechanical keying for easy mating with the header.
- With an audible click, the integrated locking lever locks the connector to the header.
- A wire cap guides the wires away from the connector either to the right or to the left.
- Robust CP terminals are specially designed to perform in high-conductivity applications and in harsh environments.

### Sealing

High performing matte seal technology is used for CP 0.635mm (.025") and CP 1.50mm (.059") terminals. Single wire-seal technology is used for CP 2.8mm (.110") terminals to secure reliable sealing for 2.8mm (.110") CP terminals.

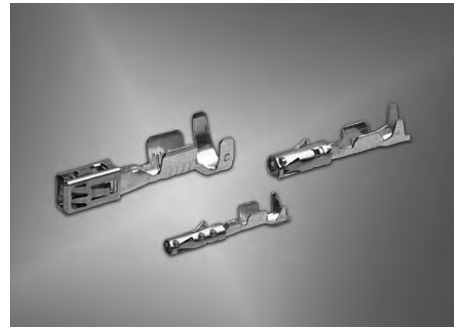

# CMC Product Family

## Part Number Overview

Circuits	Order No.		Wire Cap	Description	Color	Sealing	Mates With	Terminal Loading	
	Left Wire Output	Right Wire Output							
24	<a href="#">64319-2211</a>			CMC Receptacle	black	mat	N/A	18 x CP 0.6 terminal 6 x CP 1.5 terminal	
	<a href="#">64319-2218</a>				grey				
		<a href="#">64319-4211</a>			black				
		<a href="#">64319-4218</a>			grey				
			<a href="#">64319-1201</a>	For CMC Receptacle	N/A		N/A		
28	<a href="#">64318-1011</a>	<a href="#">64318-3011</a>		Power CMC Receptacle	black	mat	Contact Molex	18 x CP 0.6 terminal 5 x CP 1.5 terminal 5 x CP 2.8 terminal	
	<a href="#">64318-1018</a>	<a href="#">64318-3018</a>			grey				
	<a href="#">64318-1019</a>	<a href="#">64318-3019</a>			brown				
			<a href="#">64320-1301</a>		For CMC Receptacle				N/A
32	<a href="#">64319-1211</a>	<a href="#">64319-3211</a>		CMC Receptacle	black	mat	Contact Molex	24 x CP 0.6 terminal 8 x CP 1.5 terminal	
	<a href="#">64319-1216</a>	<a href="#">64319-3216</a>			blue				
	<a href="#">64319-1218</a>	<a href="#">64319-3218</a>			grey				
	<a href="#">64319-1219</a>	<a href="#">64319-3219</a>			brown				
			<a href="#">64319-1201</a>	For CMC Receptacle	N/A		N/A		
36	<a href="#">64320-2311</a>			CMC Receptacle	black	mat	48 circuit header with 36 circuit loaded 36638-0006/36638-0008	30 x CP 0.6 terminal 6 x CP 1.5 terminal	
	<a href="#">64320-2319</a>				brown		48 circuit header with 36 circuit loaded 36638-0007/36638-0009		
		<a href="#">64320-4311</a>			black		48 circuit header with 36 circuit loaded 36638-0006/36638-0008		
		<a href="#">64320-4319</a>			brown		48 circuit header with 36 circuit loaded 36638-0007/36638-0009		
			<a href="#">64320-1301</a>		For CMC Receptacle		N/A		N/A
48	<a href="#">64320-1311</a>			CMC Receptacle	black	mat	48 circuit CMC header/98 circuit CMC header 36638-0001 up to 36638-0012 48 circuit CMC header 500762-0481	40 x CP 0.6 terminal 8 x CP 1.5 terminal	
	<a href="#">64320-1315</a>				green		N/A		
	<a href="#">64320-1318</a>				grey		N/A		
	<a href="#">64320-1319</a>				brown		48 circuit CMC header/96 circuit CMC header 36638-0001 up to 36638-0012 80 circuit CMC header 502225-0801		
		<a href="#">64320-3311</a>			black		48 circuit CMC header/98 circuit CMC header 36638-0001 up to 36638-0012 48 circuit CMC header 500762-0481		
		<a href="#">64320-3315</a>			green		N/A		
		<a href="#">64320-3318</a>			grey		N/A		
		<a href="#">64320-3319</a>			brown		48 circuit CMC header/98 circuit CMC header 36638-0001 up to 36638-0012		
			<a href="#">64320-1301</a>		For CMC Receptacle		N/A		N/A
53	<a href="#">64321-1011</a>	<a href="#">64321-2011</a>		Power CMC Receptacle	black	mat	53 circuit CMC header 98997-1002	40 x CP 0.6 terminal 8 x CP 1.5 terminal 5 x CP 2.8 terminal	
	<a href="#">64321-1018</a>	<a href="#">64321-2018</a>			grey				
	<a href="#">64321-1019</a>	<a href="#">64321-2019</a>			brown				
			<a href="#">64321-1101</a>		For CMC Receptacle				N/A

For more details please refer to [www.molex.com](http://www.molex.com)

# CMC Product Family

## Part Number Overview

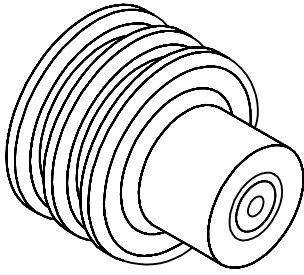

### CMC CP Terminal

Order No.	Pitch	Plating	Wire Size	Mates With
<a href="#">64322-1019</a>	0.635mm (.025")	Tin	0.35mm <sup>2</sup>	32 circuit CMC Receptacle 48 circuit CMC Receptacle  28 circuit CMC Receptacle 53 circuit CMC Receptacle
<a href="#">64322-1029</a>			0.75mm <sup>2</sup>	
<a href="#">64322-1039</a>			0.5mm <sup>2</sup>	
<a href="#">64322-1219</a>			0.75mm <sup>2</sup>	
<a href="#">64322-1229</a>			0.35mm <sup>2</sup>	
<a href="#">64322-1239</a>		0.5 mm <sup>2</sup>	Gold 1.27µm	
<a href="#">64322-1339</a>		0.75mm <sup>2</sup>		
<a href="#">64322-1349</a>		0.35mm <sup>2</sup>		
<a href="#">64322-1359</a>		0.5 mm <sup>2</sup>		
<a href="#">64323-1029</a>		1.50mm (.059")		
<a href="#">64323-1039</a>			>1 to 2mm <sup>2</sup>	
<a href="#">64323-1219</a>	Gold 1.27µm		>1 to 2mm <sup>2</sup>	
<a href="#">64323-1319</a>			0.5 to 1mm <sup>2</sup>	
<a href="#">64324-1019</a>	2.80mm (.110")	Tin	>3 to 5mm <sup>2</sup>	28 circuit CMC Receptacle 53 circuit CMC Receptacle
<a href="#">64324-1029</a>			>2 to 3mm <sup>2</sup>	
<a href="#">64324-1039</a>			>1 to 2mm <sup>2</sup>	
<a href="#">64324-1049</a>			0.5 to 1mm <sup>2</sup>	
<a href="#">64324-1119</a>			>3 to 5mm <sup>2</sup>	
<a href="#">64324-1129</a>		>2 to 3mm <sup>2</sup>		
<a href="#">64324-1139</a>		>1 to 2mm <sup>2</sup>		
<a href="#">64324-1149</a>		0.5 to 1mm <sup>2</sup>		
		0.5 to 1mm <sup>2</sup>		

For more details please refer to [www.molex.com](http://www.molex.com)

### CMC Blind Plugs

Order No.	Wire Size	Mates With
<a href="#">64325-1010</a>	0.635mm (.025")	32 circuit CMC Receptacle
<a href="#">64325-1023</a>	1.50mm (.059")	48 circuit CMC Receptacle
<a href="#">64325-1091</a>	2.80mm (.110")	28 circuit CMC Receptacle 53 circuit CMC Receptacle

### CMC Single Wire Seals

Order No.	Color	Cable Size	Mates With
<a href="#">64325-1162</a>	Red	1.29 to 2.06mm	CMC CP 2.80 (.110") terminal
<a href="#">64325-1175</a>	Green	2.03 to 2.8mm	
<a href="#">64325-1188</a>	Grey	2.8 to 3.5mm	
<a href="#">64325-1196</a>	Blue	3.5 to 4.21mm	

**2.54mm (.100")/  
3.50mm (.138")/  
6.75mm (.266") Pitch  
CMC  
Wire-to-Board  
Power Hybrid Connector  
Receptacle, Plug and Wire  
Cap  
64318  
28 Circuit  
Left and Right Wire Output**

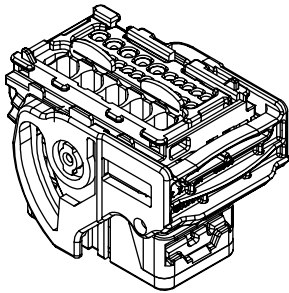

**Features and Benefits**

- CMC is a sealed, standard and modular connecting system
- Available in several circuit sizes
- Sealed by using high performing matte seal technology
- High density connector
- Hybrid system carrying low, medium and high current
- Used with CMC CP Terminals
- Using CMC CP 2.80 mm terminals for power connecting applications

**Reference Information**

Product Specification: PS-64318-001  
Mates With: 28 circuit CMC header coming soon,  
please contact Molex for details

**Use With:**

Terminal: 64322 CMC CP 0.635mm (.025")  
64323 CMC CP 1.50mm (.059")  
64324 CMC CP 2.80mm (.110")

Plug: 64325-1010 Plug 0.635mm (.025") cavity  
64325-1023 Plug 1.50mm (.059") cavity  
64325-1091 Plug 2.80mm (.110") cavity

Wire Cap: 64320-1301 CMC Wire Cap for 48 circuit  
and 28 circuit CMC Receptacle

Designed In: Millimeters

**Electrical**

Voltage: 250V AC

Current: \*

2.5A for CMC CP 0.635mm (.025") terminal (0.75mm<sup>2</sup> wire)  
12.0A for CMC CP 1.50mm (.059") terminal (2.0mm<sup>2</sup> wire)  
21.0A for CMC CP 2.80mm (.110") terminals (5.0mm<sup>2</sup>)

Contact Resistance:

CMC CP 0.635mm (.025")—8 milliohms max.  
CMC CP 1.50mm (.059")—4 milliohms max.  
CMC CP 2.80mm (.110")—3 milliohms max.

Dielectric Withstanding Voltage: 1000V AC for 1 minute

Insulation Resistance: 100 Megohms min.

**Mechanical**

Contact Insertion Force:

CMC CP 0.635mm (.025")—12.00N max.  
CMC CP 1.50mm (.059")—20.00N max.  
CMC CP 2.80mm (.110")—25.00N max.

Contact Retention to Housing:

CMC CP 0.635mm (.025")—60.00N min.  
CMC CP 1.50mm (.059")—100.00N min.  
CMC CP 2.80mm (.110")—100.00N min.

Wire Pull-Out Force: 100.00N min.

Mating Force: 70.00N max.

Unmating Force: 70.00N max.

Durability: 20 mating cycles

**Physical**

Housing: Glass-filled PBT

\* Current tested on a fully loaded connector, current for temperature increase of 40°C

CMC Power Receptacle				
Circuits	Order No.	Coding	Wire output	Lead-Free
28	<a href="#">64318-1011</a>	Black	Left	Yes
	<a href="#">64318-1018</a>	Grey		
	<a href="#">64318-1019</a>	Brown		
	<a href="#">64318-3011</a>	Black	Right	
	<a href="#">64318-3018</a>	Grey		
	<a href="#">64318-3019</a>	Brown		

CMC Wire Cap			
Circuits	Order No.	Housing Color	Lead-Free
For 28 circuit (same wire cap as for 48 circuit CMC Receptacle)	<a href="#">64320-1301</a>	Black	Yes

CMC Plug			
Circuits	Order No.	Housing Color	Lead-Free
0.635mm (.025")	<a href="#">64325-1010</a>	White	Yes
1.50mm (.059")	<a href="#">64325-1023</a>	Orange	
2.80mm (.110")	<a href="#">64325-1091</a>	Black	

# 2.54mm (.100")/ 3.70mm (.146") Pitch CMC Wire-to-Board Hybrid Connector Receptacle, Plug and Wire Cap

**64319**  
**32 Circuit**  
**Left and Right Wire Output**

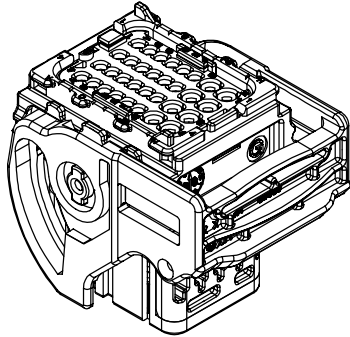

### Features and Benefits

- CMC is a sealed, standard and modular connecting system
- Available in several circuit sizes
- Sealed by using high performing matte seal technology
- High density connector
- Hybrid system carrying low and medium current
- Used with CMC CP Terminals

### Reference Information

Product Specification: PS-64319-001

Mates With:

Single 32 circuit CMC header—please contact Molex

80 circuit CMC header 502225-0801 (32 + 48 circuit)

Use With:

Terminal: 64322 CMC CP 0.635mm (.025")

64323 CMC CP 1.50mm (.059")

Plug: 64325-1010 Plug 0.635mm (.025") cavity

64325-1023 Plug 1.50mm (.059") cavity

Wire Cap: 64319-1201 CMC Wire Cap for 32 circuit

CMC Receptacle

Header: 80 circuit CMC header 502225-0801 (32 + 48 circuit)

Designed In: Millimeters

### Electrical

Voltage: 250V AC

Current: \*

6.0A for CMC CP 0.635mm (.025") terminal (0.75mm<sup>2</sup> wire)

12.0A for CMC CP 1.50mm (.059") terminal (2.0mm<sup>2</sup> wire)

Contact Resistance:

CMC CP 0.635mm (.025")—8 milliohms max.

CMC CP 1.50mm (.059")—4 milliohms max.

Dielectric Withstanding Voltage: 1000V AC for 1 minute

Insulation Resistance: 100 Megohms min.

### Mechanical

Contact Insertion Force:

CMC CP 0.635mm (.025")—12.00N max.

CMC CP 1.50mm (.059")—20.00N max.

Contact Retention to Housing:

CMC CP 0.635mm (.025")—60.00N min.

CMC CP 1.50mm (.059")—100.00N min.

Wire Pull-Out Force: 100.00N min.

Mating Force: 70.00N max.

Unmating Force: 70.00N max.

Durability: 20 mating cycles

### Physical

Housing: Glass-filled PBT

\* Current tested on a 5 terminals loaded connector, current for temperature increase of 40°C

CMC Receptacle					
Circuits	Order No.	Coding	Wire Output	Option	Lead-Free
32	<a href="#">64319-1211</a>	Black	Left		Yes
	<a href="#">64319-1216</a>	Blue			
	<a href="#">64319-1218</a>	Grey			
	<a href="#">64319-1219</a>	Brown			
24	<a href="#">64319-2211</a>	Black		Row 1 closed	
	<a href="#">64319-2218</a>	Grey		Row 4 closed	
	<a href="#">64319-3211</a>	Black			
32	<a href="#">64319-3216</a>	Blue	Right		
	<a href="#">64319-3218</a>	Grey			
	<a href="#">64319-3219</a>	Brown			
	<a href="#">64319-4211</a>	Black		Row 1 closed	
24	<a href="#">64319-4218</a>	Grey		Row 4 closed	

CMC Wire Cap			
Circuits	Order No.	Housing Color	Lead-Free
For 32 circuit	<a href="#">64319-1201</a>	Black	Yes

CMC Plug			
Circuits	Order No.	Housing Color	Lead-Free
0.635mm (.025")	<a href="#">64325-1010</a>	White	Yes
1.50mm (.059")	<a href="#">64325-1023</a>	Orange	

# 2.54mm (.100")/ 3.70mm (.146") Pitch CMC Wire-to-Board Hybrid Connector Receptacle, Plug and Wire Cap

**64320**  
**48 Circuit**  
**Left and Right Wire Output**

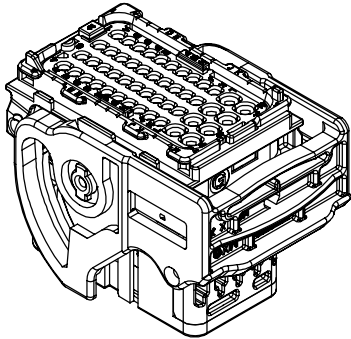

### Features and Benefits

- CMC is a sealed, standard and modular connecting system
- Several circuit sizes available
- Sealed by using high performing matte seal technology
- High density connector
- Hybrid system carrying low and medium current
- Used with CMC CP Terminals

### Reference Information

Product Specification: PS-64319-001

Mates With:

48 circuit CMC header 500762-0481 and 36638 series  
and 80 circuit CMC header 502225-0801 (32 + 48 circuit)

Use With:

Terminal: 64322 CMC CP 0.635mm (.025")

64323 CMC CP 1.50mm (.059")

Plug: 64325-1010 Plug 0.635mm (.025") cavity

64325-1023 Plug 1.50mm (.059") cavity

Wire Cap: 64320-1301 CMC Wire Cap for 48 circuit and  
28 circuit CMC Receptacle

Header: 500762-0481 48 circuit CMC header

36638 48 circuit CMC header

502225-0801 80 circuit CMC header (32 + 48  
circuit)

Designed In: Millimeters

### Electrical

Voltage: 250 V AC

Current: \*

6.0A for CMC CP 0.635mm (.025") terminal (0.75mm<sup>2</sup> wire)

12.0A for CMC CP 1.50mm (.059") terminal (2.0mm<sup>2</sup> wire)

Contact Resistance:

CMC CP 0.635mm (.025")—8 milliohms max.

CMC CP 1.50mm (.059")—4 milliohms max.

Dielectric Withstanding Voltage: 1000V AC for 1 minute

Insulation Resistance: 100 Megohms min.

### Mechanical

Contact Insertion Force:

CMC CP 0.635mm (.025")—12.00N max.

CMC CP 1.50mm (.059")—20.00N max.

Contact Retention to Housing:

CMC CP 0.635mm (.025")—60.00N min.

CMC CP 1.50mm (.059")—100.00N min.

Wire Pull-Out Force: 100.00N min.

Mating Force: 70.00N max.

Unmating Force: 70.00N max.

Durability: 20 mating cycles

### Physical

Housing: Glass-filled PBT

\* Current tested on a 5 terminals loaded connector, current for temperature increase of 40°C

CMC Receptacle					
Circuits	Order No.	Coding	Wire Output	Option	Lead-Free
48	<a href="#">64320-1311</a>	Black	Left		Yes
	<a href="#">64320-1315</a>	Green			
	<a href="#">64320-1318</a>	Grey			
	<a href="#">64320-1319</a>	Brown			
36	<a href="#">64320-2311</a>	Black		Row 1 closed	
	<a href="#">64320-2319</a>	Brown		Row 1 closed	
48	<a href="#">64320-3311</a>	Black	Right		
	<a href="#">64320-3315</a>	Green			
	<a href="#">64320-3318</a>	Grey			
	<a href="#">64320-3319</a>	Brown			
36	<a href="#">64320-4311</a>	Black		Row 1 closed	
	<a href="#">64320-4319</a>	Brown		Row 1 closed	

CMC Wire Cap			
Circuits	Order No.	Housing Color	Lead-Free
For 48 circuit	<a href="#">64320-1301</a>	Black	Yes

CMC Plug			
Circuits	Order No.	Housing Color	Lead-Free
0.635mm (.025")	<a href="#">64325-1010</a>	White	Yes
1.50mm (.059")	<a href="#">64325-1023</a>	Orange	



# 2.54mm (.100")/ 3.50mm (.138")/ 7.00mm (.276") Pitch CMC Wire-to-Board Power Hybrid Connector Receptacle, Plug and Wire Cap

**64321**  
**53 Circuit**  
**Left and Right Wire Output**

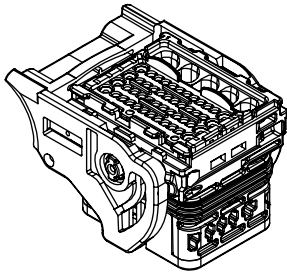

### Features and Benefits

- CMC is a sealed, standard and modular connecting system
- Available in several circuit sizes
- Sealed by using high performing matte seal technology
- High density connector
- Hybrid system carrying low, medium and high current
- Used with CMC CP Terminals
- Using CMC CP 2.80mm terminals for power connecting applications

### Reference Information

Product Specification: PS-64321-001

Mates With: 53 circuit CMC header 98997-1002,  
please contact Molex for details

Use With:

Terminal: 64322 CMC CP 0.635mm (.025")

64323 CMC CP 1.50mm (.059")

64324 CMC CP 2.80mm (.110")

Plug: 64325-1010 Plug 0.635mm (.025") cavity

64325-1023 Plug 1.50mm (.059") cavity

64325-1091 Plug 2.80mm (.110") cavity

Wire Cap: 64321-1101 CMC Wire Cap for 53 circuit  
CMC Receptacle

Designed In: Millimeters

### Electrical

Voltage: 250V AC

Current: \*

2.5A for CMC CP 0.635mm (.025") terminal (0.75mm<sup>2</sup> wire)

12.0A for CMC CP 1.50mm (.059") terminal (2.0mm<sup>2</sup> wire)

21.0A for CMC CP 2.80mm (.110") terminals (5.0mm<sup>2</sup>)

Contact Resistance:

CMC CP 0.635mm (.025")—8 milliohms max.

CMC CP 1.50mm (.059")—4 milliohms max.

CMC CP 2.80mm (.110")—3 milliohms max.

Dielectric Withstanding Voltage: 1000V AC for 1 minute

Insulation Resistance: 100 Megohms min.

### Mechanical

Contact Insertion Force:

CMC CP 0.635mm (.025")—12.00N max.

CMC CP 1.50mm (.059")—20.00N max.

CMC CP 2.80mm (.110")—25.00N max.

Contact Retention to Housing:

CMC CP 0.635mm (.025")—60.00N min.

CMC CP 1.50mm (.059")—100.00N min.

CMC CP 2.80mm (.110")—100.00N min.

Wire Pull-Out Force: 100.00N min.

Mating Force: 80.00N max.

Unmating Force: 80.00N max.

Durability: 20 mating cycles

### Physical

Housing: Glass-filled PBT

\* Current tested on a fully loaded connector, current for temperature increase of 40°C

CMC Power Receptacle				
Circuits	Order No.	Coding	Wire Output	Lead-Free
53	<a href="#">64321-1011</a>	Black	Left	Yes
53	<a href="#">64321-1018</a>	Grey	Left	
53	<a href="#">64321-1019</a>	Brown	Left	
53	<a href="#">64321-2011</a>	Black	Right	
53	<a href="#">64321-2018</a>	Grey	Right	
53	<a href="#">64320-2019</a>	Brown	Right	

CMC Wire Cap			
Circuits	Order No.	Housing Color	Lead-Free
For 53 circuit	<a href="#">64321-1101</a>	Black	Yes

CMC Plug			
Circuits	Order No.	Housing Color	Lead-Free
0.635mm (.025")	<a href="#">64325-1010</a>	White	Yes
1.50mm (.059")	<a href="#">64325-1023</a>	Orange	
2.80mm (.110")	<a href="#">64325-1091</a>	Black	

# 2.54mm (.100")/ 3.50mm (.138") Pitch Wire-to-Board CMC Hybrid Crimp Housing

**98944**  
**32 Circuits**

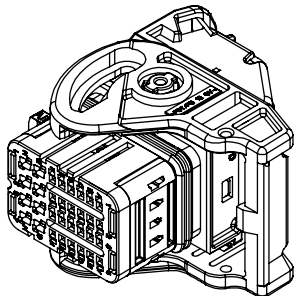

### Features and Benefits

- Secondary locking
- Gel grommet seal to facilitate harness assembly (no cavity plug necessary for unplugged cavities)
- Two wire sizes: hybrid 0.635 and 1.50mm (.025 and .060") connector

### Reference Information

Packaging: Tray  
Mates With: Various other CMC headers  
Use With: 98658, 98915-10x9 terminals and 98649-1003 (wire cap)  
Designed In: Millimeters

### Electrical

Voltage: 14V  
Current:  
0.635mm (.025") terminal—6.0A max.  
1.50mm (.060") terminal—11.0A max.  
Contact Resistance:  
0.635mm (.025") terminal—8 milliohms max.  
1.50mm (.060") terminal—4 milliohms max.  
Dielectric Withstanding Voltage: 1000V AC min.  
Insulation Resistance: 100 Megohms min.

### Mechanical

Contact Insertion Force:  
0.635mm (.025") terminal—10.00N (2.25 lb)  
1.50mm (.060") terminal—15.00N (3.37 lb)  
Contact Retention to Housing:  
0.635mm (.025") terminal—60.00N (13.49 lb)  
1.50mm (.060") terminal—100.00N (22.48 lb)  
Wire Pull-Out Force: 100.00N (22.48 lb)  
Mating Force: 80.00N (17.98 lb) max.  
Unmating Force: 80.00N (17.98 lb) max.  
Durability: 20 mating cycles

### Physical

Housing: Glass-filled PBT Polyester  
Sealing Performance: IP67

Circuits	Order No.		Color
	Assembled Right Wire Output	Assembled Left Wire Output	
32	<a href="#">98944-2001</a>	<a href="#">98944-3001</a>	Black
	<a href="#">98944-2002</a>	<a href="#">98944-3002</a>	Gray
	<a href="#">98944-2003</a>	<a href="#">98944-3003</a>	Brown
	<a href="#">98944-2004</a>	<a href="#">98944-3004</a>	Green
	<a href="#">98944-2005</a>	<a href="#">98944-3005</a>	Blue

# 2.54mm (.100")/ 3.50mm (.138") Pitch CMC Wire Cap

**98649**

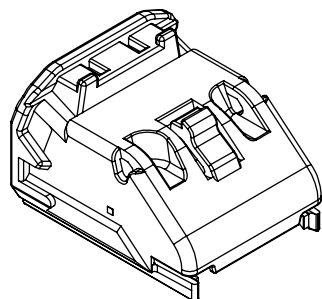

### Features and Benefits

- Fixture for strain relief
- Enable right angle wire output in two directions

### Reference Information

Packaging: Box  
Use With: 98944-200X or 98944-300X  
Designed In: Millimeters

### Physical

Material: Black PA6—Polyamide

Circuits	Order No.
32	<a href="#">98649-1003</a>

# 2.54mm (.100")/ 3.50mm (.138") Pitch Wire-to-Board CMC Hybrid Crimp Housing

**98950**  
**48 Circuits**

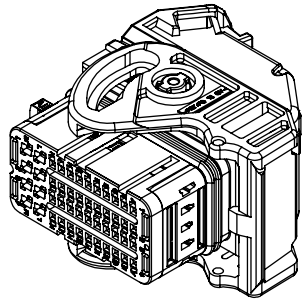

### Features and Benefits

- Secondary locking
- Gel grommet seal to facilitate harness assembly (no cavity plug necessary for unplugged cavities)
- Two wire sizes: hybrid 0.635 (.025 and .060") and 1.50mm connector

### Reference Information

Packaging: Tray  
Mates With: Various other CMC headers  
Use With: 98658, 98915-10x9 terminals  
and 98649-1003 (wire cap)  
Designed In: Millimeters

### Electrical

Voltage: 14V  
Current: 0.635mm (.025") terminal—6A max.  
1.50mm (.060") terminal—11A max.  
Contact Resistance:  
0.635mm (.025") terminal—8 milliohms max.  
1.50mm (.060") terminal—4 milliohms max.  
Dielectric Withstanding Voltage: 1000V AC min.  
Insulation Resistance: 100 Megohms min.

### Mechanical

Contact Insertion Force:  
0.635mm (.025") terminal—10.00N (2.25 lb)  
1.50mm (.060") terminal—15.00N (3.37 lb)  
Contact Retention to Housing:  
0.635mm (.025") terminal: 60.00N (13.49 lb)  
1.50mm (.060") terminal: 100.00N (22.48 lb)  
Wire Pull-Out Force: 100.00N (22.48 lb)  
Mating Force: 80.00N (17.98 lb) max.  
Unmating Force: 80.00N (17.98 lb) max.  
Durability: 20 mating cycles

### Physical

Housing: Glass-filled PBT Polyester  
Sealing Performance: IP67

Circuits	Order No.		Color
	Assembled Right Wire Output	Assembled Left Wire Output	
48	<a href="#">98950-2001</a>	<a href="#">98950-3001</a>	Black
	<a href="#">98950-2002</a>	<a href="#">98950-3002</a>	Gray
	<a href="#">98950-2003</a>	<a href="#">98950-3003</a>	Brown
	<a href="#">98950-2004</a>	<a href="#">98950-3004</a>	Green
	<a href="#">98950-2005</a>	<a href="#">98950-3005</a>	Blue

# 2.54mm (.100")/ 3.50mm (.138") Pitch CMC Wire Cap

**98655**

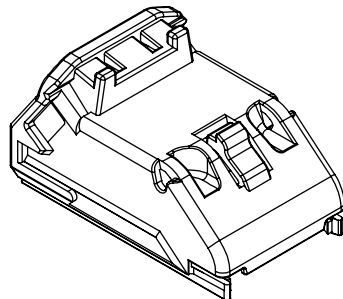

### Features and Benefits

- Fixture for strain relief
- Enable right angle wire output in two directions

### Reference Information

Packaging: Box  
Use With: 98950-200X or 98950-300X  
Designed In: Millimeters

### Physical

Material: Black PA6—Polyamide

Circuits	Order No.
48	<a href="#">98655-1003</a>

# 0.635mm (.025")/ 1.50mm (.059")/ 2.80mm (.110") Terminal Cavity CMC Hybrid Connector Blind Plug

64325

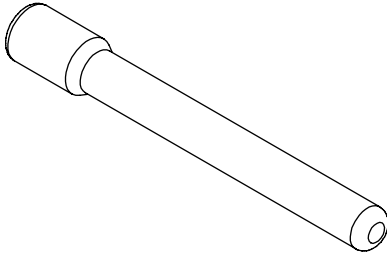

### Features and Benefits

- CMC is a sealed, standard and modular connecting system
- Several circuit sizes available
- Sealed by using high performing matte seal technology
- CMC CP blind plugs for unused circuits
- CMC CP blind plugs secure sealing system when flexibility is required for unused cavities with standard backplate

### Reference Information

Product Specification:

Please refer to Product Specification of the relevant CMC connector

Mates With:

CMC Plug 0.635mm (.025") and CMC Plug 1.50mm (.059")—CMC connector series 64318, 64319, 64320, and 64321

CMC Plug 2.80mm (.110")—CMC connector series 64318 and 64321

Use With: See under Mates With

Designed In: Millimeters

### Physical

CMC CP Plug 0.635mm (.025"): White Polyamid

CMC CP Plug 1.50mm (.059"): Orange Polyamid

CMC CP Plug 2.80mm (.110"): Black Rubber

For CMC CP terminal cavity	Order No.	Color	Material
0.635mm (.025")	<a href="#">64325-1010</a>	White	Polyamid
1.50mm (.059")	<a href="#">64325-1023</a>	Orange	Polyamid
2.80mm (.110")	<a href="#">64325-1091</a>	Black	Rubber

# 0.635mm (.025") Width CMC CP Female Crimp Terminal

64322

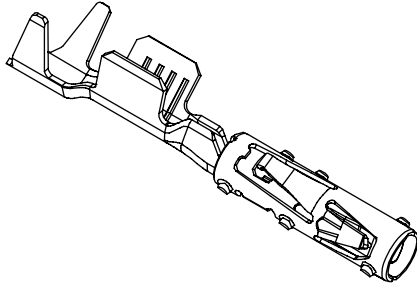

### Features and Benefits

- Two piece terminal design
- Tang locking system
- Robust design with fully protected beam
- Various wire size compatibility
- Available in tin and gold plating

### Reference Information

Product Specification: Please refer to Product Specification of the relevant CMC connector

Mates With: CMC connector series 64318, 64319, 64320 and 64321

Designed In: Millimeters

### Electrical

Voltage: 250V AC

Current: \*

6.0A for CMC CP 0.635mm (.025") terminal (0.75mm<sup>2</sup> wire)

Contact Resistance: CMC CP 0.635mm (.025") 8 milliohms max.

Dielectric Withstanding Voltage: 1000V AC for 1 min.

Insulation Resistance: 100 Megohms min.

### Mechanical

Contact Insertion Force into Housing (Sealed Connector):

CMC CP 0.635mm (.025")—12.00N min.

Wire Pull-Out Force: 100.00N min. for wire size of 0.50mm<sup>2</sup>

Mating/Unmating Force:

Please refer to Product Specification of the relevant

CMC connector the terminal is used with

Durability: 20 mating cycles

### Physical

Contact: Phosphor Bronze

Plating: Tin and Gold

Insulation Diameter: See table

\* Current tested on a 5 terminals loaded connector, current for temperature increase of 40°C

Order No.	Wire Size (mm <sup>2</sup> )	Wire Insulation Diameter (mm)	Wire Size (AWG)	Plating	Lead-Free
<a href="#">64322-1019</a>	0.35	1.25 to 1.40	22, 24	Tin	Yes
<a href="#">64322-1029</a>	0.75	1.60 to 1.90		Tin	
<a href="#">64322-1039</a>	0.50	1.40 to 1.70		Tin	
<a href="#">64322-1219</a>	0.75	1.60 to 1.90		1.27µm Gold	
<a href="#">64322-1229</a>	0.35	1.25 to 1.40	22, 24	1.27µm Gold	
<a href="#">64322-1239</a>	0.50	1.40 to 1.70		1.27µm Gold	
<a href="#">64322-1339</a>	0.75	1.60 to 1.90		High Performing version 1.27µm Gold	
<a href="#">64322-1349</a>	0.35	1.25 to 1.40	22, 24	High Performing version 1.27µm Gold	
<a href="#">64322-1359</a>	0.50	1.40 to 1.70		High Performing version 1.27µm Gold	

# 1.50mm (.059") Width CMC CP Female Crimp Terminal

64323

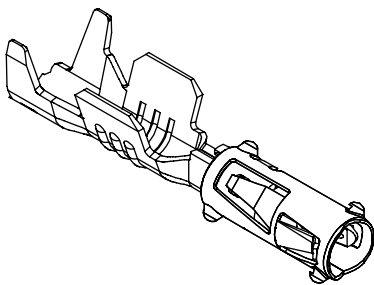

### Features and Benefits

- Two piece terminal design
- Tang locking system
- Robust design with fully protected beam
- Various wire size compatibility
- Available in tin and gold plating

### Reference Information

Product Specification:

Please refer to Product Specification of the relevant CMC connector

Mates With: CMC connector series 64318, 64319, 64320 and 64321

Designed In: Millimeters

### Electrical

Voltage: 250 V AC

Current: \*

12.0A for CMC CP 1.50mm (.059") terminal (2.0mm<sup>2</sup> wire)

Contact Resistance: CMC CP 1.50mm (.059")—4 milliohms max.

Dielectric Withstanding Voltage: 1000V AC for 1 min.

Insulation Resistance: 100 Megohms min.

### Mechanical

Contact Insertion Force into Housing (Sealed Connector):

CMC CP 1.50mm (.059")—20.00N min.

Wire Pull-Out Force: 100.00N min. for wire size of 0.50mm<sup>2</sup>

Mating/Unmating Force:

Please refer to Product Specification of the relevant

CMC connector the terminal is used with

Durability: 20 mating cycles

### Physical

Contact: Phosphor Bronze

Plating: Tin and Gold

Insulation Diameter: See table

\* Current tested on a 5 terminals loaded connector, current for temperature increase of 40°C

Order No.	Wire Size (mm <sup>2</sup> )	Wire Insulation Diameter (mm)	Wire Size (AWG)	Plating	Lead-Free
<a href="#">64323-1029</a>	0.50 to 1.00	1.40 to 2.15	18, 20	Tin	Yes
<a href="#">64323-1039</a>	> 1.00 to 2.00	2.10 to 2.80	14, 16	Tin	
<a href="#">64323-1219</a>	> 1.00 to 2.00	2.10 to 2.80	14, 16	1.27µm Gold	
<a href="#">64323-1319</a>	0.50 to 1.00	1.40 to 2.15	18, 20	1.27µm Gold	

# 2.80mm (.110") Width CMC CP Female Crimp Terminal

**64324**

**With Linked Wire Seal**

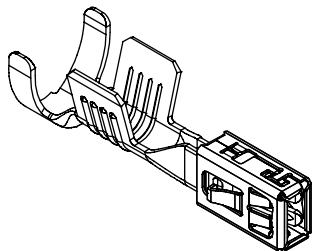

### Features and Benefits

- Two piece terminal design
- Tang locking system
- Robust design with fully protected beam
- Various wire size compatibility
- Available in tin and gold plating

### Reference Information

Product Specification:

Please refer to Product Specification of the relevant CMC connector

Mates With: CMC connector series 64318, 64321 and CMC wire seal series 64325

Designed In: Millimeters

### Electrical

Voltage: 250V AC

Current: \*21.0A for CMC CP 2.80mm (.110") terminals (5.0mm<sup>2</sup>)

Contact Resistance: CMC CP 2.80mm (.110")—3 milliohms max.

Dielectric Withstanding Voltage: 1000V AC for 1 min.

Insulation Resistance: 100 Megohms min.

\* Current tested on a fully loaded connector, current for temperature increase of 40°C

### Mechanical

Contact Insertion Force into Housing (Sealed Connector):

CMC CP 2.80mm (.110")—25.00N min

Wire Pull-Out Force: 100.00N min. for wire size of 0.50mm<sup>2</sup>

Mating/Unmating Force:

Please refer to Product Specification of the relevant

CMC connector the terminal is used with

Durability: 20 mating cycles

### Physical

Contact: Phosphor Bronze

Plating: Tin and Gold

Insulation Diameter: See table

Order No.	Wire Size (mm <sup>2</sup> )	Wire Insulation Diameter (mm)	Plating	Lead-Free
<a href="#">64324-1019</a>	> 3.0 to 5.0	3.40 to 4.00	Tin	Yes
<a href="#">64324-1029</a>	> 2.0 to 3.0	2.65 to 3.45	Tin	
<a href="#">64324-1039</a>	> 1.0 to 2.0	2.10 to 2.80	Tin	
<a href="#">64324-1049</a>	0.5 to 1.0	1.40 to 2.15	Tin	
<a href="#">64324-1119</a>	> 3.0 to 5.0	3.40 to 4.00	1.27µm Gold	
<a href="#">64324-1129</a>	> 2.0 to 3.0	2.65 to 3.45	1.27µm Gold	
<a href="#">64324-1139</a>	> 1.0 to 2.0	2.10 to 2.80	1.27µm Gold	
<a href="#">64324-1149</a>	0.5 to 1.0	1.40 to 2.15	1.27µm Gold	

[www.molex.com/product/cmc.html](http://www.molex.com/product/cmc.html)

# 3.33mm (.131")/ 4.20mm (.165") Pitch NSSC Wire-to-Wire Hybrid Receptacle Housing

**98122**

**Triple Rows  
Sealed**

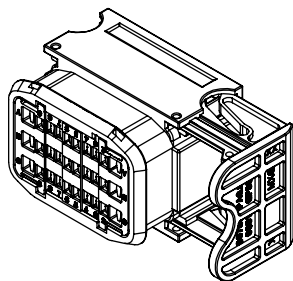

### Features and Benefits

- Secondary locking
- Slide to reduce mating force
- Slide orientation right or left
- Grommet seal and perimeter seal
- Color keying
- Two wire sizes: hybrid 1.5 and 2.8mm (.060 and .110") connector

### Reference Information

Packaging: Box

Mates With: 98761

Use With: NSSC 1.5 terminal

Designed In: Millimeters

### Electrical

Voltage: 13V

Current: 1.5mm (.060")—13.0A

2.8mm (.110")—22.0A

(see Sema terminal specification for 1.5 and 2.8mm terminals)

Contact Resistance: 1.5mm (.060")—5 milliohms max.

2.8mm (.110")—4 milliohms max.

Dielectric Withstanding Voltage: 1000 VAC or 1400 VDC

Insulation Resistance: 100 Megohms min.

### Mechanical

Contact Insertion Force:

1.5mm (.060")—25.0N (5.62 lb) max.

2.8mm (.110")—30.0N (6.74 lb) max.

Contact Retention to Housing: 120.0N (26.98 lb) min.

Wire Pull-Out Force: 120.0N (26.98 lb)

Mating Force: 85.0N (19.11 lb) max. (fully loaded)

Unmating Force: 85.0N (19.11 lb) max. (fully loaded)

Durability: 10 mating cycles

### Physical

Housing: Glass-filled PBT Polyester, UL 94V-HB

Sealing Class: 500 mbars (7.25 psi)

Circuits	Order No.	Color	Slide Orientation
30	<a href="#">98122-1001</a>	Black	Right
	<a href="#">98122-1002</a>	Brown	
	<a href="#">98122-1003</a>	Gray	
	<a href="#">98122-1005</a>	Black	Left
	<a href="#">98122-1006</a>	Brown	
	<a href="#">98122-1007</a>	Gray	

# 3.33mm (.131")/ 4.20mm (.165") Pitch NSSC Wire-to-Wire Hybrid Plug Housing

**98761**  
Triple Rows  
Sealed

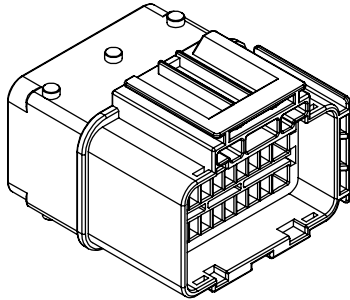

Circuits	Order No.	Color
30	<a href="#">98761-1001</a>	Black
	<a href="#">98761-1002</a>	Brown
	<a href="#">98761-1003</a>	Gray

## Features and Benefits

- Secondary locking feature
- Slide to reduce mating force
- Slide orientation right or left possible
- Grommet seal and perimeter seal
- Color keying
- Two wire sizes: hybrid 1.50 and 2.80mm (.060 and .110") connector

## Reference Information

Packaging: Box

Mates With: 98122

Use With: Sicma 1.5 and 2.8mm (.060 and .110") male terminals

Designed In: Millimeters

## Electrical

Voltage: 13V

Current: 1.5mm (.060")—13.0A

2.8mm (.110")—22.0A

(see FCI Sicma terminal specification for 1.5 and 2.8mm terminals)

Contact Resistance: 1.5mm (.060")—5 milliohms max.

2.8mm (.110")—4 milliohms max.

Dielectric Withstanding Voltage: 1000V AC or 1400V DC

Insulation Resistance: 100 Megohms min.

## Mechanical

Contact Insertion Force:

1.5mm (.060")—15.0N (3.37 lb) max.

2.8mm (.110")—20.0 N (4.50 lb) max.

Contact Retention to Housing: 120.0 N (26.98 lb) min.

Wire Pull-Out Force: 120.0N (26.98 lb)

Mating Force: 85.0N (19.11 lb) max. (fully loaded)

Unmating Force: 85.0N (19.11 lb) max. (fully loaded)

Durability: 10 mating cycles

## Physical

Housing: Glass-filled PBT Polyester, UL 94-HB

Sealing Class: 500 mbars (7.25 psi)



# Bulb Socket Sealed Terminal

**35464**  
Positive Lock

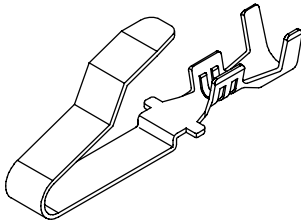

Order No.	Wire Range (mm <sup>2</sup> )	Lead-free
<a href="#">35464-8000</a>	AVS (AVSS) 0.3-0.85	Yes

### Features and Benefits

- Positive locking terminal
- Available for sealed or unsealed systems

### Reference Information

Product Specification: PS-35842-001  
 Packaging: Reel  
 Use With: 35842 and 35843  
 Mates With: 35903 Wire Seal  
 Designed In: Millimeters

### Electrical

Voltage: 12V  
 Current:

Wire Size	Current
0.5 mm <sup>2</sup>	5A
0.85 mm <sup>2</sup>	7A

Contact Resistance: 10 milliohms max.  
 Dielectric Withstanding Voltage: 1000V AC  
 Insulation Resistance: 500V DC 100 Megohms min.

### Mechanical

Contact Insertion Force: 3.0 kgf max.  
 Contact Retention to Housing: 6.0 kgf min.

### Physical

Contact: Phosphor Bronze  
 Plating: Contact Area—Unplated  
 Insulation Diameter: 1.90mm (.075") max.  
 Strip Length: 2.60 to 3.60mm (.102 to .142")

[www.molex.com/customer.html?seriesNumber=35464](http://www.molex.com/customer.html?seriesNumber=35464)

# Bulb Socket Sealed Terminal

**35465**  
Earth

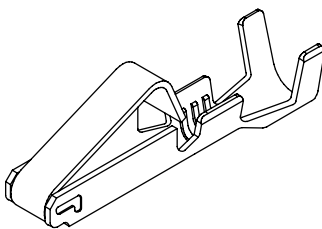

Order No.	Wire Range (mm <sup>2</sup> )	Lead-free
<a href="#">35465-8000</a>	AVS (AVSS) 0.3-0.85	Yes

### Features and Benefits

- Positive locking terminal
- Available for sealed or unsealed systems

### Reference Information

Product Specification: PS-35842-001  
 Packaging: Reel  
 Use With: 35842 and 35843  
 Mates With: 35903 Wire Seal  
 Designed In: Millimeters

### Electrical

Voltage: 12V  
 Current:

Wire Size	Current
0.5 mm <sup>2</sup>	5
0.085 mm <sup>2</sup>	7

Contact Resistance: 10 milliohms max.  
 Dielectric Withstanding Voltage: 1000V AC  
 Insulation Resistance: 100 Megohms min.

### Mechanical

Contact Insertion Force: 3.0 kgf max.  
 Contact Retention to Housing: 6.0 kgf min.

### Physical

Contact: Phosphor Bronze  
 Plating: Unplated

## Bulb Socket

**35843**  
Sealed, Single

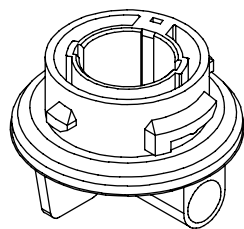

### Features and Benefits

- Used with: 21/5W for double bulb 21W for single bulb
- High temperature material
- Compact size provides space saving
- Easy insertion "push-to-seat" terminal design provides cost savings
- Bottom flange enables easy assembly with lamp
- Simplified lamp design by standardization of light center length
- Silicone wire seal provides good sealing

### Reference Information

Product Specification: PS-35842-001  
Packaging: Bag  
Mates With: Lamp  
Use With: 35464 and 35465  
Designed In: Millimeters

### Electrical

Voltage: 12V  
Current: 7.0A max.  
Contact Resistance: 10 milliohms max.  
Dielectric Withstanding Voltage: 1000V AC  
Insulation Resistance: 500V DC 100 Megohms min.

### Mechanical

Contact Insertion Force: 3.0 kgf max.  
Contact Retention Force: 6.0 kgf min.  
Wire Pull-Out Force: 58.3N (13.23 lb) min.  
Durability: 50 cycles

### Physical

Housing: High-temperature Polyamide, UL 94V-2

Order No.	Type	Color
<a href="#">35843-1205</a>	A	Gray
<a href="#">35843-1206</a>		White
<a href="#">35843-1210</a>	B	Natural
<a href="#">35843-1211</a>		Black
<a href="#">35843-1215</a>		Gray
<a href="#">35843-1216</a>		White
<a href="#">35843-1217</a>	C	Brown
<a href="#">35843-1221</a>		Black
<a href="#">35843-1225</a>		Gray
<a href="#">35843-1226</a>		White
<a href="#">35843-1227</a>		Brown

Order No.	Type	Color
<a href="#">35843-1240</a>	D	Natural
<a href="#">35843-1245</a>		Gray
<a href="#">35843-1246</a>		White
<a href="#">35843-1247</a>		Brown
<a href="#">35843-1230</a>	EC	Natural
<a href="#">35843-1235</a>		Gray
<a href="#">35843-1236</a>		White
<a href="#">35843-1237</a>		Brown

[www.molex.com/customer.html?seriesNumber=35843](http://www.molex.com/customer.html?seriesNumber=35843)

## Bulb Socket

**35842**  
Sealed, Double

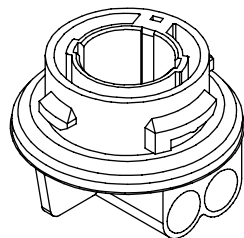

### Features and Benefits

- Used with: 21/5W for double bulb 21W for double bulb
- High temperature material
- Compact size provides space saving
- Easy insertion "push-to-seat" terminal design provides cost savings
- Bottom flange enables easy assembly with lamp
- Simplified lamp design by standardization of light center length
- Silicone wire seal provides good sealing

### Reference Information

Product Specification: PS-35842-001  
Packaging: Bag  
Mates With: Lamp  
Use With: 35464 and 35465  
Designed In: Millimeters

### Electrical

Voltage: 12V  
Current: 7.0A max.  
Contact Resistance: 10 milliohms max.  
Dielectric Withstanding Voltage: 1000V AC  
Insulation Resistance: 500V DC 100 Megohms min.

### Mechanical

Contact Insertion Force: 3.0 kgf max.  
Contact Retention Force: 6.0 kgf min.  
Wire Pull-Out Force: 58.3N (13.23 lb) min.  
Durability: 50 cycles

### Physical

Housing: High-temperature Polyamide, UL 94V-2

Order No.	Type	Color
<a href="#">35842-1301</a>	A	Black
<a href="#">35842-1305</a>		Gray
<a href="#">35842-1306</a>		White
<a href="#">35842-1307</a>		Brown
<a href="#">35842-1315</a>	B	Gray
<a href="#">35842-1316</a>		White
<a href="#">35842-1317</a>		Brown

# HSAutoLink™ Cable Assembly

111015/111082/111083

## USCAR USB Standard A Receptacle to USCAR USB Plug

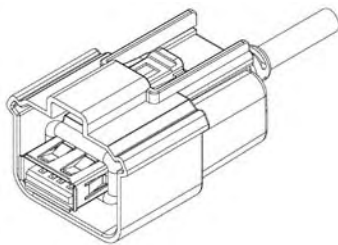

Latching Shroud

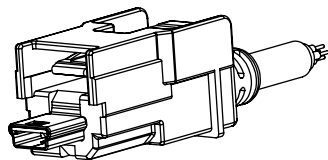

Plug

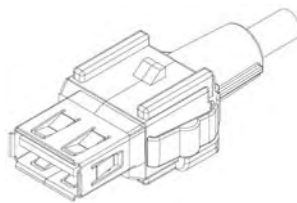

Unshrouded

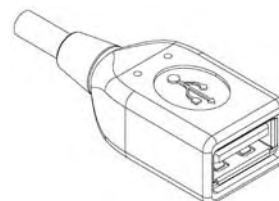

Overmolded

### Features and Benefits

- Rugged connectors meet USCAR and other automotive OEM requirements
- Superior signal performance and reduced Electro Magnetic Interference (EMI)
- USCAR-30 compliant
- High durability Standard A receptacle
- Package size optimization of the consumer interface

### Reference Information

Packaging: Bag  
 Mates With: USCAR USB Keyed Headers—Right Angle (49616), Vertical (104004)  
 Use With: In-Line Cable Assemblies 111005 for separating link applications  
 Designed In: Millimeters

### Electrical

Voltage: 30V  
 Current: 1.5A  
 Contact Resistance: 50 milliohms max.  
 Insulation Resistance: 150 Megohms min.

### Mechanical

USB Standard A  
 Mating Force: 35N (7.87 lb) max.  
 Unmating Force: 10N (2.25 lb) min.  
 Durability: 5,000 cycles\*  
 \*Durability results range from 5,000 cycles to as many as 20,000 cycles based on test methods used  
 Plug: Shielded 5 Pin  
 Mating Force: 45N (10.12 lb) max.  
 Retention Force: 110N (24.73 lb) max.  
 Durability: 25 cycles

### Physical

Housing: PBT  
 Interface Plating: Gold over Nickel

Order No.	Plug Polarization	Standard A	Length*
<a href="#">111015-0100</a>	A	Latching Shroud	0.50m (1.64')
<a href="#">111015-0101</a>	B		
<a href="#">111015-0200</a>	A		1.00m (3.28')
<a href="#">111015-0201</a>	B		
<a href="#">111015-0300</a>	A		1.50m (4.92')
<a href="#">111015-0301</a>	B		
<a href="#">111082-0001</a>	A	Overmolded	0.50m (1.64')
<a href="#">111082-0002</a>	B		
<a href="#">111083-0001</a>	A	Unshrouded	
<a href="#">111083-0002</a>	B		

\*Other lengths available, contact Molex.

# HSAutoLink™ Cable Assembly

## 111014 USCAR USB Plug to Plug

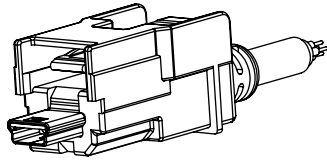

### Features and Benefits

- Rugged connectors meet USCAR and other automotive OEM requirements
- Superior signal performance and reduced Electro Magnetic Interference (EMI)
- USCAR-30 compliant

### Reference Information

Packaging: Bag  
 Mates With: USCAR USB Keyed Headers—Right Angle (49616), Vertical (104004)  
 Use With: Cable Assemblies 111005  
 Designed In: Millimeters

### Electrical

Voltage: 30V  
 Current: 1.5A  
 Contact Resistance: 50 milliohms max.  
 Insulation Resistance: 150 Megohms min.

### Mechanical

Plug: Shielded 5 Pin  
 Mating Force: 45N (10.12 lb) max.  
 Unmating Force: 45N (10.12 lb) max.  
 Retention Force: 110N (24.73 lb) min.  
 Durability: 25 cycles  
 Inline Receptacle: Shielded 5 Pin  
 Mating Force: 45N (10.12 lb) max.  
 Unmating Force: 45N (10.12 lb) max.  
 Retention Force: 110N (24.73 lb) min.  
 Durability: 25 cycles

### Physical

Housing: PBT  
 Interface Plating: Gold over Nickel

Order No.	In-Line Receptacle	Plug Polarization	Length*
<a href="#">111014-5000</a>	A	A	0.50m (1.64')
<a href="#">111014-5001</a>		B	
<a href="#">111014-5003</a>	B	A	
		B	

\*Other lengths available, contact Molex.

# HSAutoLink™ Cable Assembly

## 111005 USCAR USB Plug to In-line Receptacle

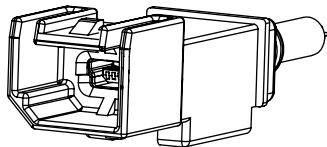

### Features and Benefits

- Rugged connectors meet USCAR and other automotive OEM requirements
- Superior signal performance and reduced Electro Magnetic Interference (EMI)
- USCAR-30 compliant
- Integrated retainer slot for standard Christmas-tree clip

### Reference Information

Packaging: Bag  
 Mates With: USCAR USB Keyed Headers—Right Angle (49616), Vertical (104004)  
 Use With: Cable Assemblies 111014, 111015  
 Designed In: Millimeters

### Electrical

Voltage: 30V  
 Current: 1.5A  
 Contact Resistance: 50 milliohms max.  
 Insulation Resistance: 150 Megohms min.

### Mechanical

Plug: Shielded 5 Pin  
 Mating Force: 45N (10.12 lb) max.  
 Unmating Force: 45N (10.12 lb) max.  
 Retention Force: 110N (24.73 lb) min.  
 Durability: 25 cycles  
 Inline Receptacle: Shielded 5 Pin  
 Mating Force: 45N (10.12 lb) max.  
 Unmating Force: 45N (10.12 lb) max  
 Retention Force: 110N (24.73 lb) min.  
 Durability: 25 cycles

### Physical

Housing: PBT  
 Interface Plating: Gold over Nickel

Order No.	In-Line Receptacle	Plug Polarization	Length*
<a href="#">111005-1010</a>	A	A	0.50m (1.64')
<a href="#">111005-1020</a>		B	
<a href="#">111005-1030</a>	B	A	
<a href="#">111005-1040</a>		B	

\*Other lengths available, contact Molex.

# HSAutoLink™ Header

## 104004 Vertical

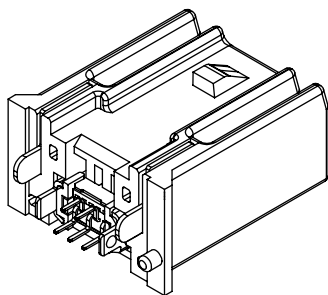

Order No.	Plug Polarization*
<a href="#">104004-0501</a>	A
<a href="#">104004-0505</a>	B

\*For applications where additional plug polarizations are required, contact Molex.

### Features and Benefits

- Provides a proven interface offering good mechanical performances
- USCAR-30 compliant
- Meets all USB 2.0 electrical and EMI requirements
- Compatible with Lead-free through-hole reflow process (Pin-in-Paste)

### Reference Information

Packaging: Tray  
 Mates With: Cable Assemblies (Series 111005, 111014, 111015, 111019, 111020 and 111041)  
 Designed In: Millimeters

### Electrical

Voltage: 16V AC min.  
 Current: 1.0A max.  
 Contact Resistance: 50 milliohms max.  
 Insulation Resistance: 150 Megohms min.

### Mechanical

Insertion Force to PCB: 20N (4.50 lb) max.  
 Mating Force: 45N (10.12 lb) max.  
 Unmating Force: 45N (10.12 lb) max.  
 Durability: 25 cycles min.

### Physical

Housing: LCP High-Temperature Plastic  
 Contact: Copper Alloy  
 Plating: Contact Area—0.75µm min. Gold  
           Solder Tail Area—3.0µm min. Tin  
           Underplating—1.25µm min. Nickel  
 PCB Thickness: 1.60mm (.063")

# HSAutoLink™ Header

## 49616 Right Angle

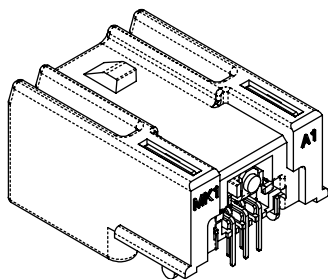

Order No.	Plug Polarization*
<a href="#">49616-0711</a>	A
<a href="#">49616-0715</a>	B

\*For applications where additional plug polarizations are required, contact Molex.

### Features and Benefits

- Provides a proven interface offering good mechanical performances
- USCAR-30 compliant
- Meets all USB 2.0 electrical and EMI requirements
- Compatible with Lead-free through-hole reflow process (Pin-in-Paste)

### Reference Information

Packaging: Tray  
 Mates With: Cable Assemblies (Series 111005, 111014, 111015, 111019, 111020 and 111041)  
 Designed In: Millimeters

### Electrical

Voltage: 16.0V AC min.  
 Current: 1.0A max.  
 Contact Resistance: 50 milliohms max.  
 Insulation Resistance: 150 Megohms min.

### Mechanical

Insertion Force to PCB: 20N (4.50 lb) max.  
 Mating Force: 45N (10.12 lb) max.  
 Unmating Force: 45N (10.12 lb) max.  
 Durability: 25 cycles min.

### Physical

Housing: LCP High-Temperature Plastic  
 Contact: Copper Alloy  
 Plating: Contact Area—0.75µm min. Gold  
           Solder Tail Area—3.0µm min. Tin  
           Underplating—1.25µm min. Nickel  
 PCB Thickness: 1.60mm (.063")

# HSAutoLink™ Cable Assembly

**111019/111041**  
**LVDS 2- and 4-Wire**

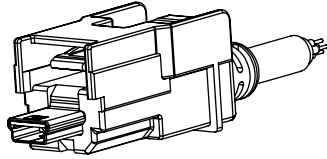

Plug

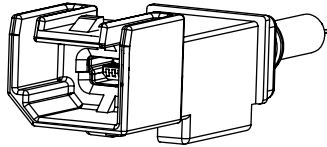

In-line Receptacle

### Features and Benefits

- Rugged connectors meet USCAR and other automotive OEM requirements
- Support 2 or 4 wire LVDS technology
- Use of high electrical performance Shielded Twisted Pair cable construction
- Interconnect system already evaluated with most of major LVDS chip suppliers for automotive application

### Reference Information

Packaging: Bag  
Mates With: USCAR USB Keyed Headers—Right Angle  
(Series 49616), Vertical (Series 104004)  
Designed In: Millimeters

### Electrical

Voltage: 30V  
Current: 1.0A  
Contact Resistance: 50 milliohms max.  
Insulation Resistance: 150 Megohms min.

### Mechanical

Plug: Shielded 5 Pin  
Mating Force: 45N (10.12 lb) max.  
Unmating Force: 45N (10.12 lb) max.  
Retention Force: 110N (24.73 lb) min.  
Durability: 25 cycles

Inline Receptacle: Shielded 5 Pin  
Mating Force: 45N (10.12 lb) max.  
Unmating Force: 45N (10.12 lb) max.  
Retention Force: 110N (24.73 lb) min.  
Durability: 25 cycles

### Physical

Housing: PBT  
Interface Plating: Gold over Nickel

### Plug to Plug Cable Assembly

Wires	Order No.	In-Line Receptacle	Plug Polarization	Length*
2	<a href="#">111041-5001</a>	A	A	0.50m (1.64')
	<a href="#">111041-5000</a>		B	
	<a href="#">111041-5002</a>	B	A	
4	<a href="#">111019-5001</a>	A	A	
	<a href="#">111019-5000</a>		B	
	<a href="#">111019-5002</a>	B	A	

### In-Line Receptacle to Plug Cable Assembly

Wires	Order No.	In-Line Receptacle	Plug Polarization	Length*
2	<a href="#">111041-2010</a>	A	A	0.50m (1.64')
	<a href="#">111041-2030</a>		B	
	<a href="#">111041-2020</a>	B	A	
	<a href="#">111041-2040</a>		B	
4	<a href="#">111019-2010</a>	A	A	
	<a href="#">111019-2030</a>		B	
	<a href="#">111019-2020</a>	B	A	
	<a href="#">111019-2040</a>		B	

\*Other lengths available, contact Molex.