

Fiber Optic Detector

OPF482

OPF482

- High speed, low capacitance
- Popular ST[®] style receptacle
- Pre-tested with fiber to assure performance
- Component pre-mounted and ready to use
- 100MHz operation minimum

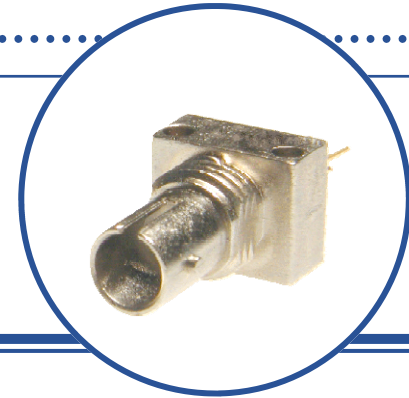

The OPF482 is a low noise silicon PIN photodiode mounted in a low cost package for fiber optic applications. It offers fast response at moderate bias and is compatible with LED and laser diode sources in the 800-1000 nm wavelength region. Low capacitance improves signal to noise performance in typical short haul LAN applications.

The OPF482 is designed to be compatible with multimode optical fibers from 50/125 to 200/300 microns.

Applications

- ◆ Industrial Ethernet equipment
- ◆ Copper-to-fiber media conversion
- ◆ Intra-system fiber optic links
- ◆ Video surveillance systems



RoHS

Typical Responsivity

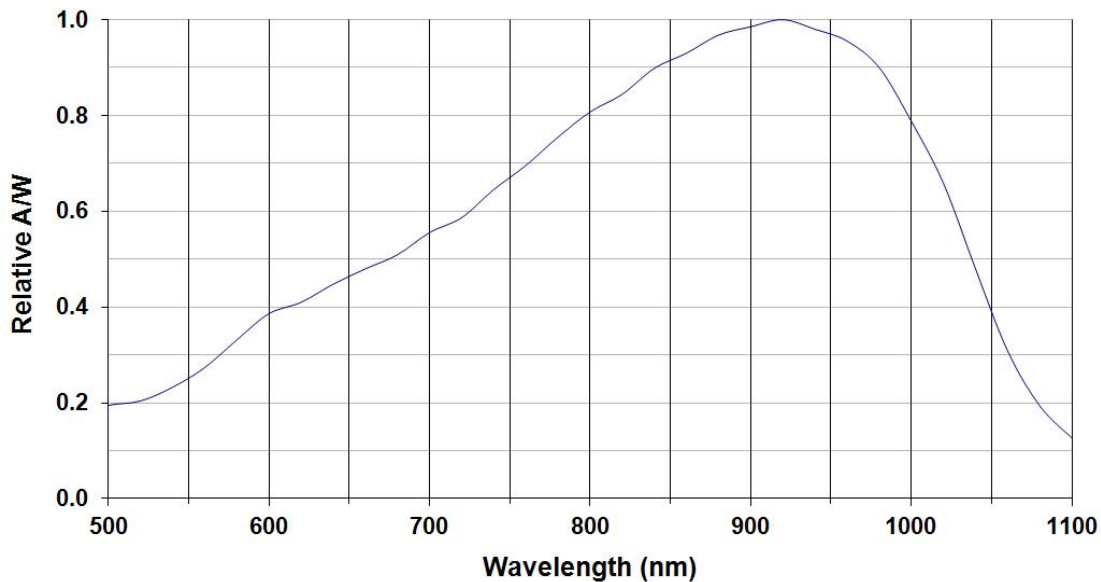

ST[®] is a registered trademark of AT&T.

OPTEK reserves the right to make changes at any time in order to improve design and to supply the best product possible.

Absolute Maximum Ratings

$T_A = 25^\circ\text{C}$ unless otherwise noted

Storage Temperature Range	-55° C to +100° C
Operating Temperature Range	-40° C to +85° C
Lead Soldering Temperature ⁽¹⁾	260° C
Continuous Power Dissipation ⁽²⁾	200 mW
Maximum Reverse Voltage	100 VDC

Electrical/Optical Characteristics ($T_A = 25^\circ\text{C}$ unless otherwise noted)

SYMBOL	PARAMETER	MIN	TYP	MAX	UNITS	CONDITIONS
R	Responsivity	0.45	0.55		A/W	$V_R = 5.0\text{V}$; 50/125 μm fiber; $\lambda = 850\text{nm}$
I_D	Dark Current		0.1	5.0	nA	$V_R = 5.0\text{V}$
λ_p	Peak Response Wavelength		905		nm	
t_r	Output Rise Time		2.0		ns	$V_R = 5\text{V}$; $R_L = 50\Omega$, 10%-90%
C_T	Total Capacitance		1.5	2.0	pF	$V_R = 5\text{V}$

Notes:

- Maximum of 5 seconds with soldering iron. Duration can be extended to 10 seconds when flow soldering. RMA flux is recommended.
- De-rate linearly at 2.67mW/°C above 25°C .

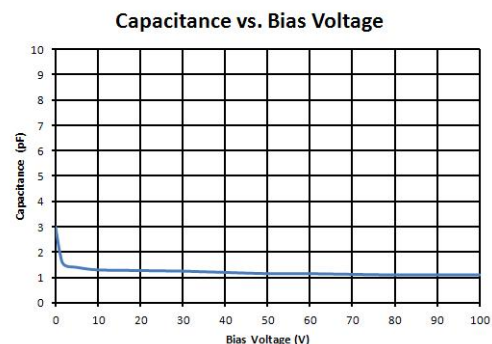
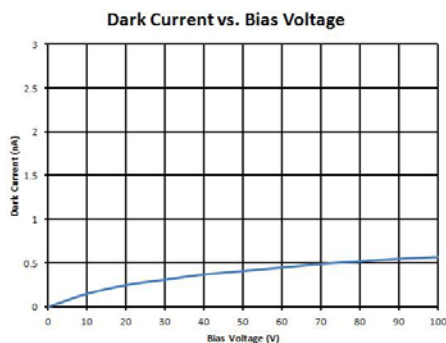
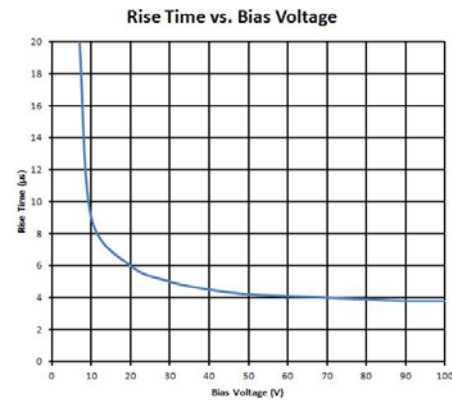
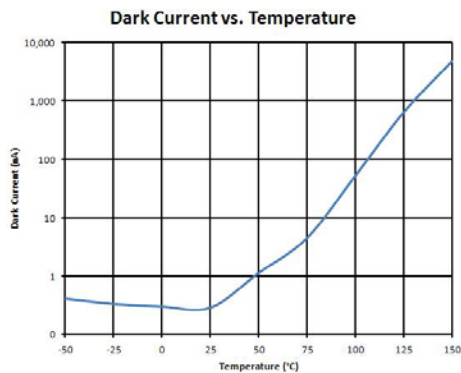

OPTEK reserves the right to make changes at any time in order to improve design and to supply the best product possible.

Mechanical Data

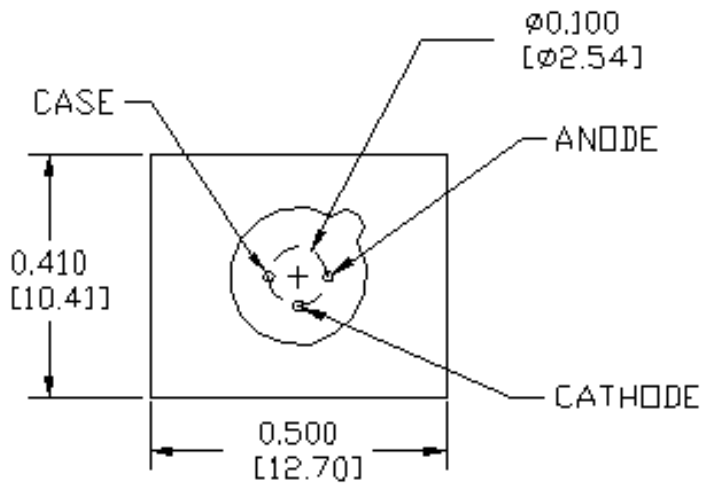
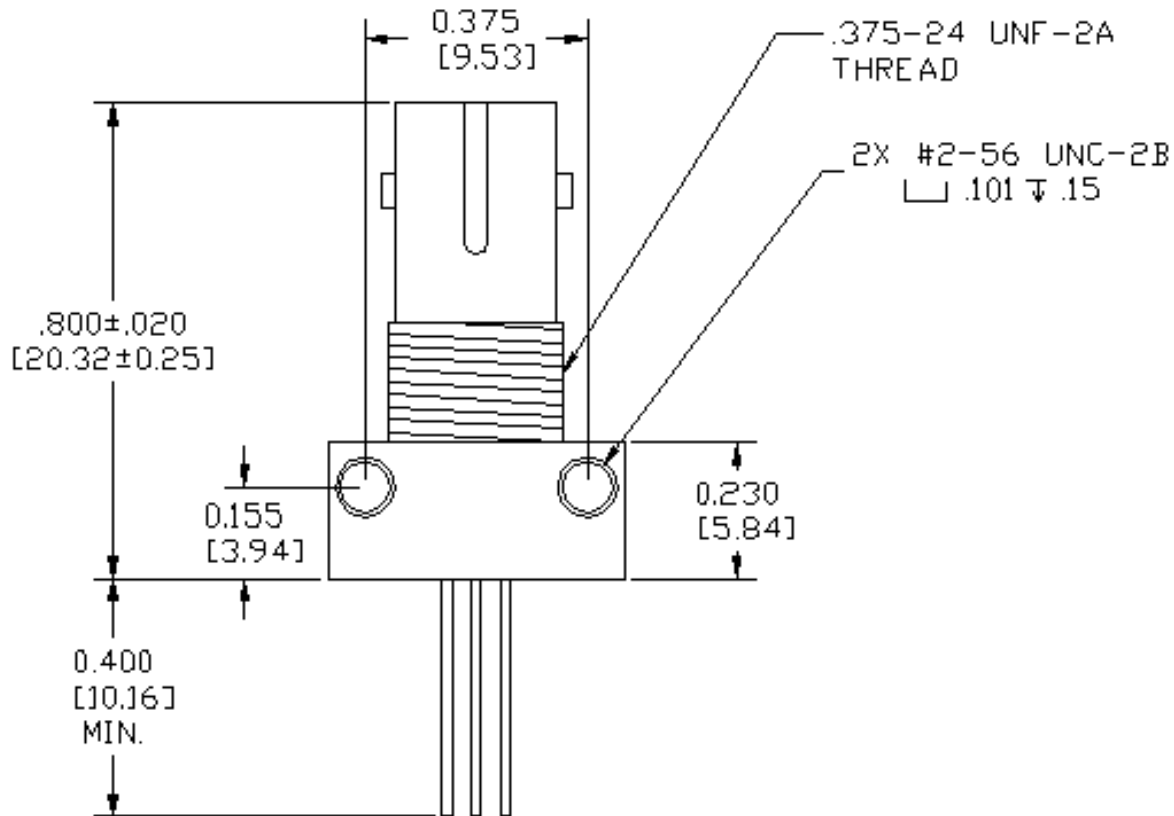

DIMENSIONS ARE IN INCHES (MILLIMETERS)

OPTEK reserves the right to make changes at any time in order to improve design and to supply the best product possible.