

GRM31CF50J226ZE01#

"#" indicates a package specification code.

Available   Complies with RoHS

< List of part numbers with package codes >
GRM31CF50J226ZE01L , GRM31CF50J226ZE01K

Shape

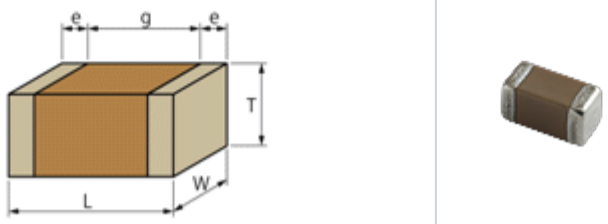
	
L size	3.2 ± 0.2mm
W size	1.6 ± 0.2mm
T size	1.6 ± 0.2mm
External terminal width e	0.3 to 0.8mm
Distance between external terminals g	1.5mm min.
Size code in inch(mm)	1206 (3216)

References

Packaging	Specifications	Minimum quantity
L	180mm Embossed taping	2000
K	330mm Embossed taping	6000

Mass (typ.)	
1 piece	52mg
180mm Reel	144g

Specifications

Capacitance	22µF +80/-20%
Rated voltage	6.3Vdc
Temperature characteristics (complied standard)	Y5V(EIA)
Capacitance change rate	+22.0/-82.0%
Temperature range of temperature characteristics	-30 to 85
Operating temperature range	-30 to 85

Attention

- 1.This datasheet is downloaded from the website of Murata Manufacturing Co., Ltd. Therefore, it ' s specifications are subject to change or our products in it may be discontinued without advance notice. Please check with our sales representatives or product engineers before ordering.
- 2.This datasheet has only typical specifications because there is no space for detailed specifications. Therefore, please review our product specifications or consult the approval sheet for product specifications before ordering.