

FME COAXIAL CONNECTORS

All connector bodies, unless otherwise noted, are nickel. All contacts are gold plated, 3µ". Insulators are Delrin. Silver plating and Teflon insulators are available for all connectors.

Please contact Connex for samples and quotes.

All dimensions are shown in millimeters [inches].

CABLE GROUP LEGEND

01	58/ 58A/ 58C/ 141/ 303/ LMR195™/ B7806A	06A	179/ U DOUBLE BRAIDED	09	B8227/ 89207
01A	55/ 142/ 223/ 400	07	8/ 8A/ 213/ 393	10	.141 SEMI-RIGID/ 402/U
01B	LMR200™/ B7807A	07A	214	11	.085 SEMI-RIGID/ 405/U
02	58 PLENUM/THINNET/ 122U/ B88240/ B89907	07B	8X/ LMR240™/ B7808A	12	.250 SEMI-RIGID
03	59/ 62/ 140/ 210	07C	B9913/ LMR400™/ B7810A/ B8214	13	.047 SEMI-RIGID/ B1674A
03A	59/ U-20AWG	07D	B89913	14	178/ 196
04	59/ U PLENUM	07E	11	15	B8281/ B9231/ B9141
04A	59/ U PLENUM-20AWG	07F	11/ U-14AWG/ B8213/ B9292/ B7731/ B1859A	15A	B88281
05	174/ 188A/ 316/ B7805A	08	6/ 143/ 212	16	180/ 195/ 122/ B8218/ B1865A/ B1855
05A	316/ U DOUBLE BRAIDED	08A	B1694A/ B9248	17	LMR600™
06	179/ 187/ B9221	08B	6 PLENUM/ B1695A	18	AT&T734A/ B1505A
				19	AT&T735A/ B735A1

CRIMP ATTACHMENTS FOR FLEXIBLE CABLE

STRAIGHT CRIMP PLUG

P.N.	Cable Group	Finish	Insulation	Impedance	Crimp Tool
192100	01	Nickel	Teflon	50	A
192115	03	Nickel	Teflon	50	A
192114	05	Nickel	Teflon	50	B

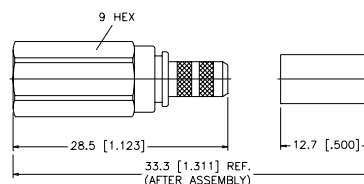
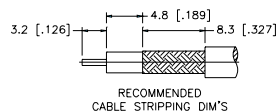

STRAIGHT CRIMP JACK

P.N.	Cable Group	Finish	Insulation	Impedance	Crimp Tool
Teflon/Captured					
192101	01	Nickel	Teflon	50	A
Delrin/Noncaptured					
192102	01	Nickel	Delrin	50	A
192111	05	Nickel	Delrin	50	B
192116	07B	Nickel	Delrin	50	A

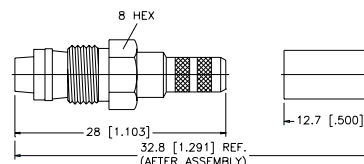
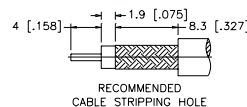

FME COAXIAL CONNECTORS

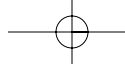

ROTATING NIPPLE ADAPTERS

For Cable Group Legend, see page 167

NIPPLE PLUG TO NIPPLE PLUG

P.N.	Cable Group	Finish	Insulation	Impedance	Crimp Tool
192103	N/A	Nickel	Teflon	50	N/A

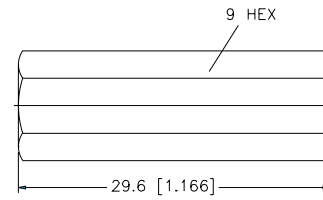

NIPPLE PLUG TO BNC PLUG

P.N.	Cable Group	Finish	Insulation	Impedance	Crimp Tool
192104	N/A	Nickel	Delrin	50	N/A

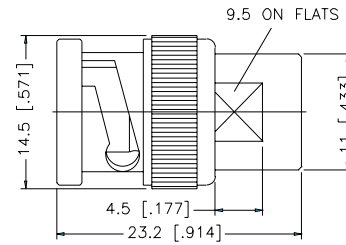

NIPPLE PLUG TO TNC PLUG

P.N.	Cable Group	Finish	Insulation	Impedance	Crimp Tool
192105	N/A	Nickel	Delrin	50	N/A

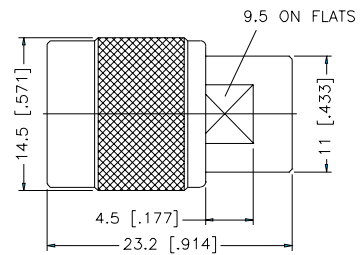

RIGHT ANGLE ADAPTER — NIPPLE PLUG TO BNC PLUG

P.N.	Cable Group	Finish	Insulation	Impedance	Crimp Tool
192106	N/A	Nickel	Delrin	50	N/A

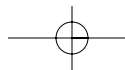
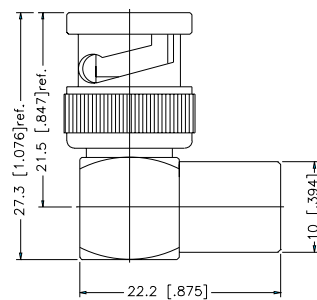

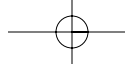

ROTATING NIPPLE ADAPTERS

For Cable Group Legend, see page 167

RIGHT ANGLE ADAPTER — NIPPLE PLUG TO TNC PLUG

P.N.	Cable Group	Finish	Insulation	Impedance	Crimp Tool
192107	N/A	Nickel	Delrin	50	N/A

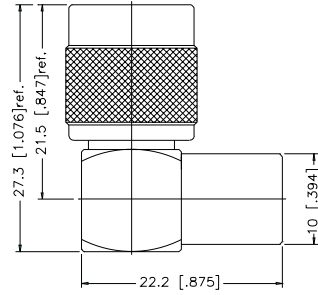

NIPPLE PLUG TO MINI-UHF PLUG

P.N.	Cable Group	Finish	Insulation	Impedance	Crimp Tool
192108	N/A	Nickel	Delrin	50	N/A

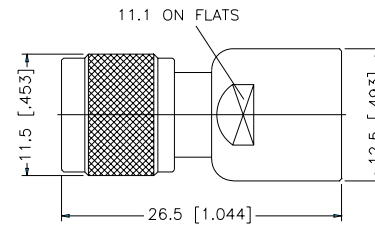

NIPPLE PLUG TO N PLUG

P.N.	Cable Group	Finish	Insulation	Impedance	Crimp Tool
192109	N/A	Nickel	Delrin	50	N/A

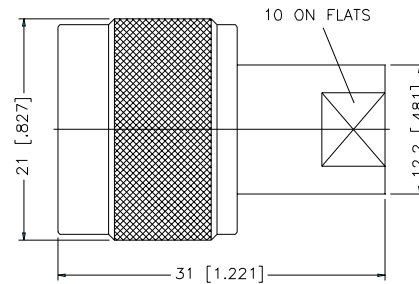

NIPPLE PLUG TO UHF PLUG

P.N.	Cable Group	Finish	Insulation	Impedance	Crimp Tool
192110	N/A	Nickel	Delrin	50	N/A

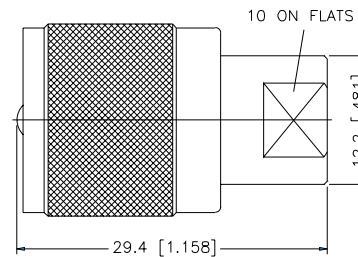

For Crimp Tool information, see page 183.

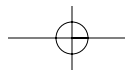

ROTATING NIPPLE ADAPTERS

For Cable Group Legend, see page 167

NIPPLE PLUG TO SMA JACK

P.N.	Cable Group	Finish	Insulation	Impedance	Crimp Tool
192112	N/A	Nickel	Teflon	50	N/A

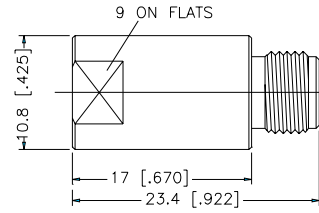

NIPPLE PLUG TO SMA PLUG

P.N.	Cable Group	Finish	Insulation	Impedance	Crimp Tool
192113	N/A	Nickel	Teflon	50	N/A

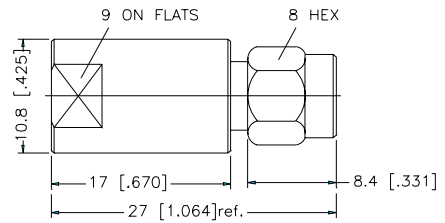

NIPPLE PLUG TO MCX PLUG

P.N.	Cable Group	Finish	Insulation	Impedance	Crimp Tool
192117	N/A	Gold	Teflon	50	N/A

