



SERIES EG SWITCHES

SLIDE SWITCHES

TACT. SWITCHES

NAVIGATION SWITCHES

PUSHBUTTON SWITCHES

TOGGLE SWITCHES

ROCKER SWITCHES

SLIDE SWITCHES

SNAP-ACTION SWITCHES

DIP SWITCHES

KEYLOCK SWITCHES

ROTARY SWITCHES

DETECTOR SWITCHES

CAP. OPTIONS



SPECIFICATIONS

Contact Resistance:	Less than 20 milliohms
Insulation Resistance:	500VDC – 100 milliohms
Dielectric Strength:	500V AC for 1 minute between any terminal and frame
Operating Temperature:	-20°C to +70°C (-4°F to +158°F)

FEATURES & BENEFITS

- ▶ Variety of package styles & sizes
- ▶ Up to 6 poles
- ▶ Variety of functions
- ▶ Positive detent
- ▶ SMT options

APPLICATIONS/MARKETS

- ▶ Computer servers/peripherals
- ▶ Consumer electronics
- ▶ Instrumentation
- ▶ Test & measurement

MATERIALS

Contact: Silver plated copper alloy

▶ ▶ ▶ Example Ordering Number
EG-1201A

HOW TO ORDER



Specifications subject to change without notice.

EG 1201

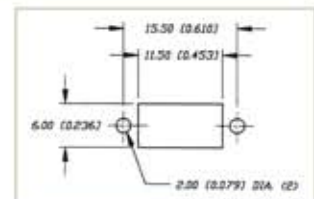
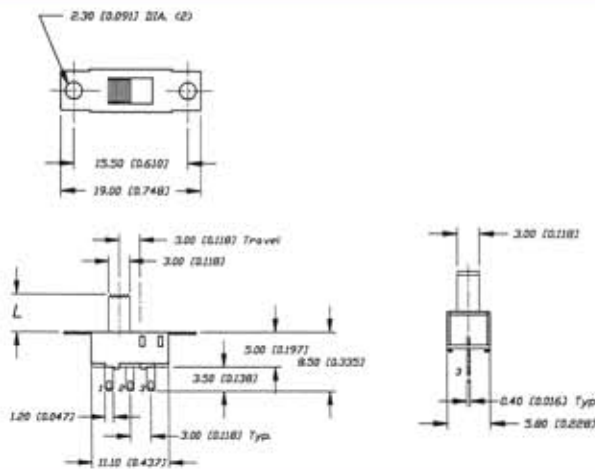

PANEL MOUNT

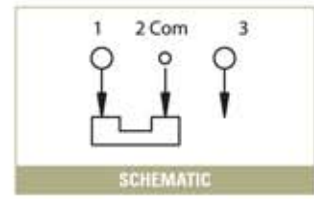

SCHEMATIC

Model No.	L
EG1201	4
EG1201A	5.5

EG 1205

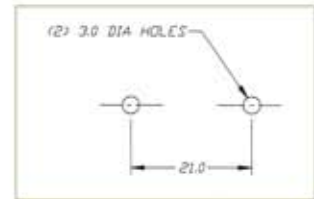
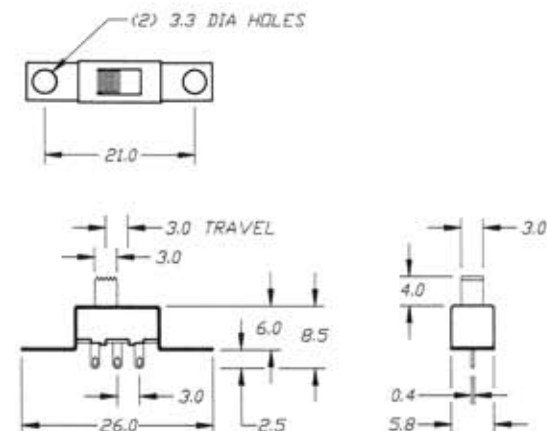

PANEL MOUNT

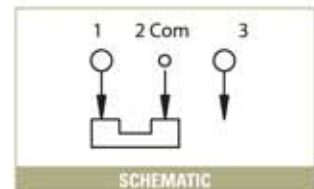

SCHEMATIC

Model No.	L
EG1205	4
EG1205A	5.5



EG 1206



Model No.	L
EG1206	3
EG1206A	6

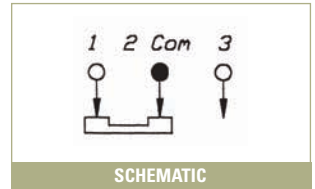
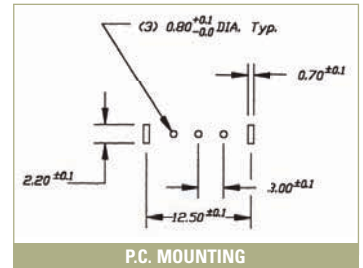
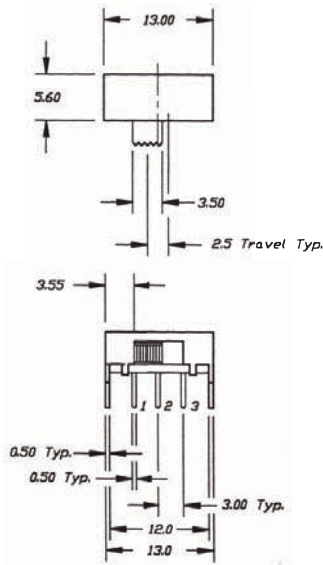

EG 1213

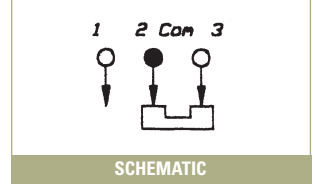
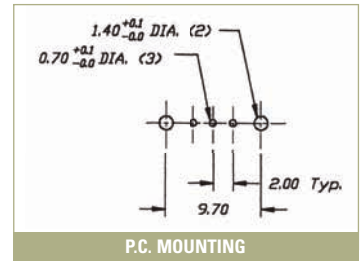
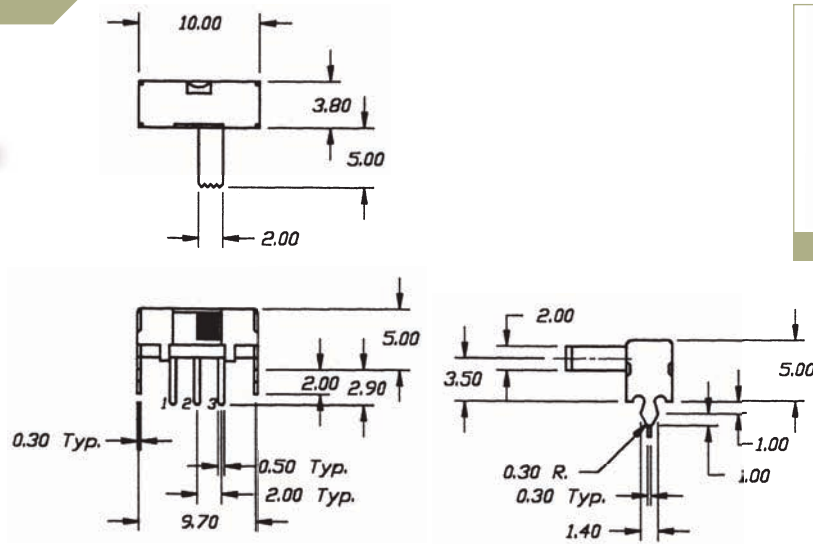
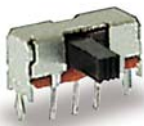

EG 1218

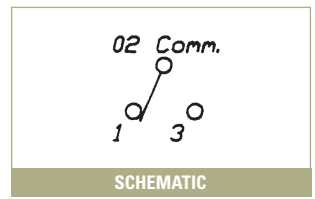
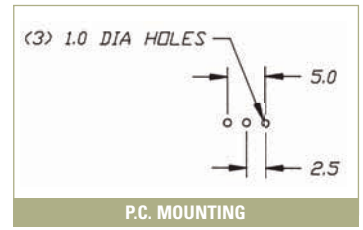
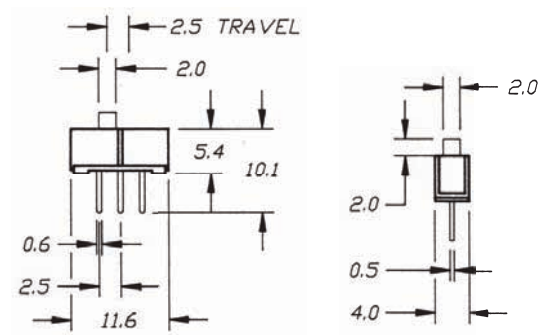

TACT SWITCHES
 NAVIGATION SWITCHES
 PUSHBUTTON SWITCHES
 TOGGLE SWITCHES
 ROCKER SWITCHES
 SLIDE SWITCHES
 SNAP-ACTION SWITCHES
 DIP SWITCHES
 KEYLOCK SWITCHES
 ROTARY SWITCHES
 DETECTOR SWITCHES
 CAP OPTIONS



SERIES EG SWITCHES

SLIDE SWITCHES

TACT SWITCHES

NAVIGATION SWITCHES

PUSHBUTTON SWITCHES

TOGGLE SWITCHES

ROCKER SWITCHES

SLIDE SWITCHES

SNAP-ACTION SWITCHES

DIP SWITCHES

KEYLOCK SWITCHES

ROTARY SWITCHES

DETECTOR SWITCHES

CAP OPTIONS

EG 1224

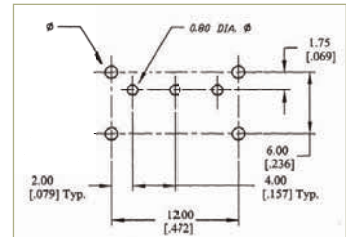
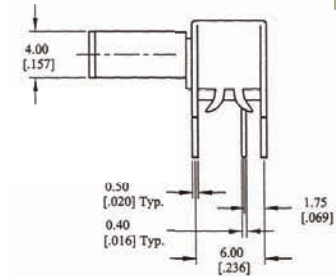
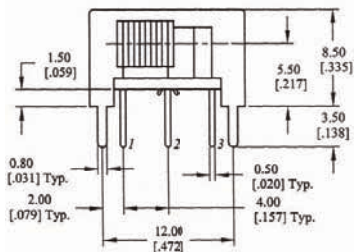
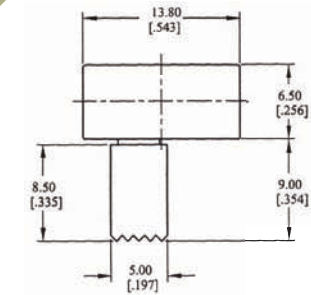

P.C. MOUNTING

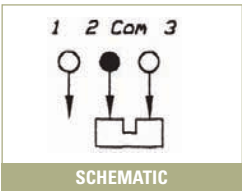

SCHEMATIC

EG 1247

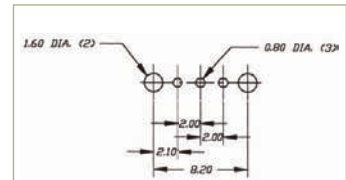
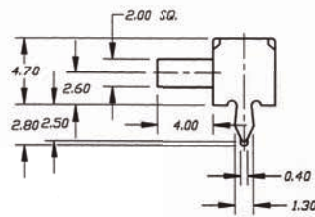
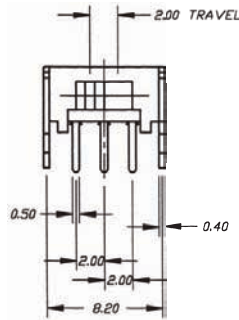
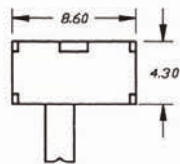

P.C. MOUNTING

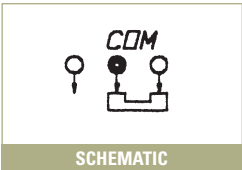

SCHEMATIC

EG 1248

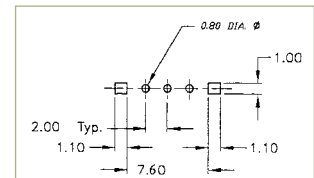
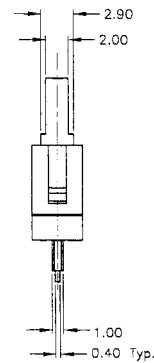
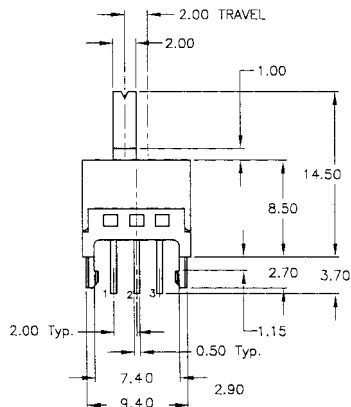
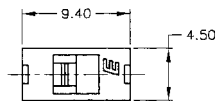

P.C. MOUNTING

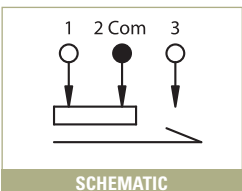

SCHEMATIC



EG 1249

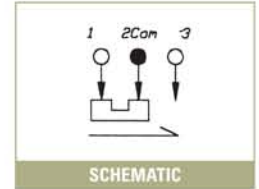
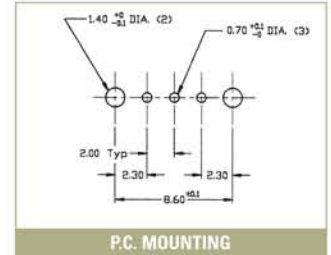
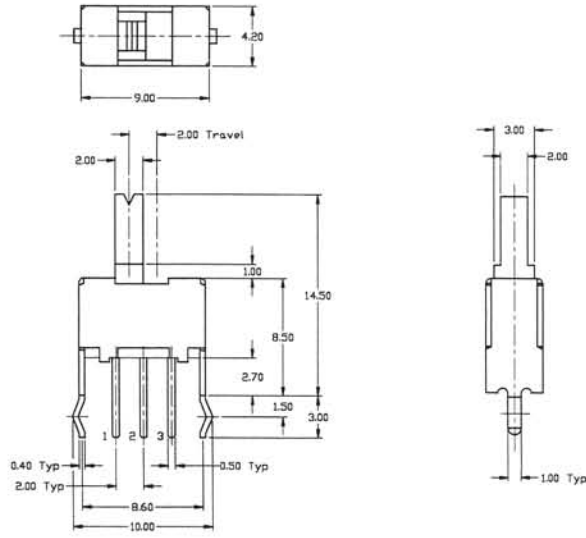

- TACT SWITCHES
- NAVIGATION SWITCHES
- PUSHBUTTON SWITCHES
- TOGGLE SWITCHES
- ROCKER SWITCHES
- SLIDE SWITCHES**
- SNAP-ACTION SWITCHES
- DIP SWITCHES
- KEYLOCK SWITCHES
- ROTARY SWITCHES
- DETECTOR SWITCHES
- CAP OPTIONS



SERIES EG SWITCHES

SLIDE SWITCHES

TACT SWITCHES

NAVIGATION SWITCHES

PUSHBUTTON SWITCHES

TOGGLE SWITCHES

ROCKER SWITCHES

SLIDE SWITCHES

SNAP-ACTION SWITCHES

DIP SWITCHES

KEYLOCK SWITCHES

ROTARY SWITCHES

DETECTOR SWITCHES

CAP. OPTIONS

EG 1270

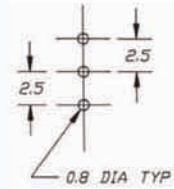
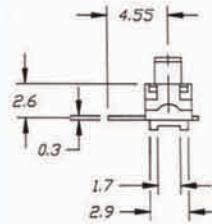
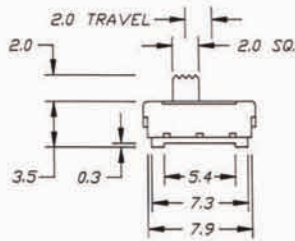
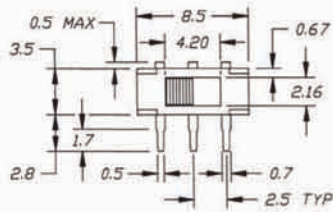

P.C. MOUNTING

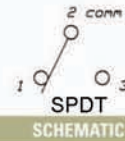

SPDT SCHEMATIC

EG 1271

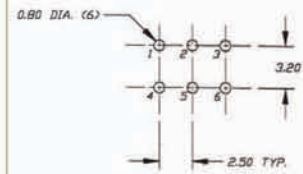
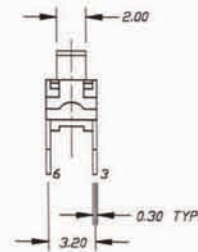
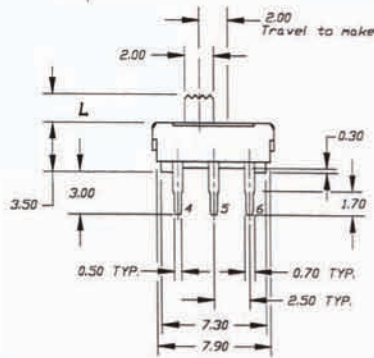
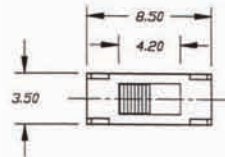

P.C. MOUNTING

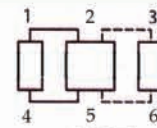

SPDT SCHEMATIC

Model No.	L
EG1271	2
EG1271A	4.4



EG 1307

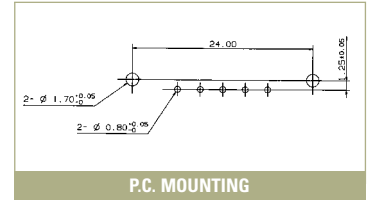
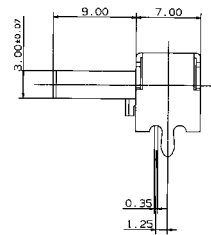
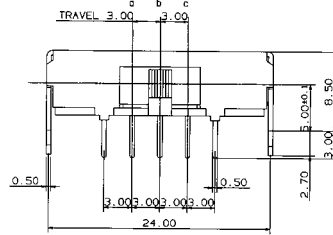
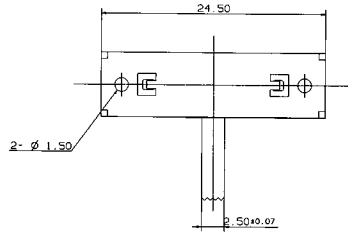

P.C. MOUNTING

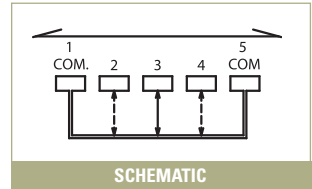

SCHEMATIC

EG 1313

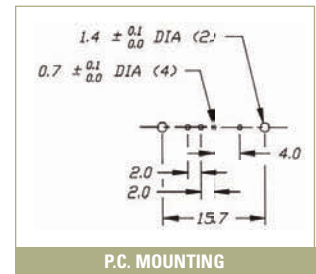
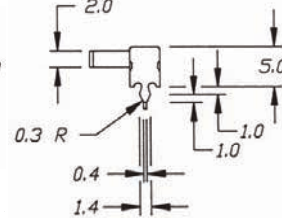
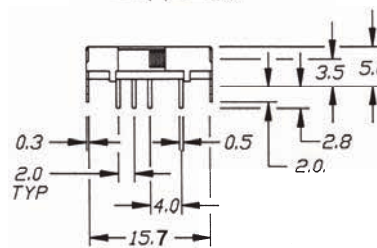
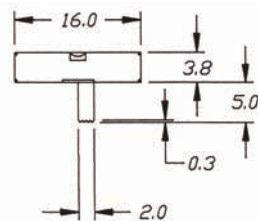

P.C. MOUNTING

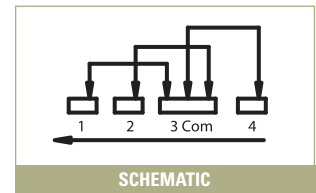

SCHEMATIC

EG 2201

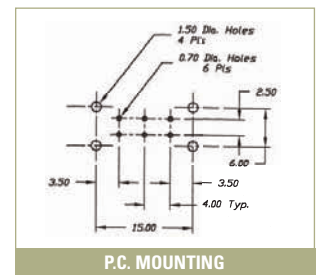
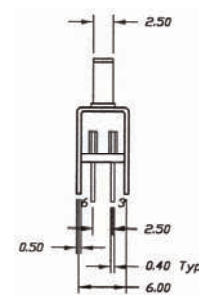
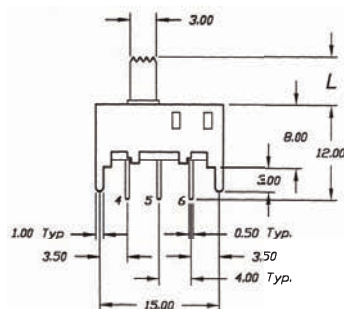
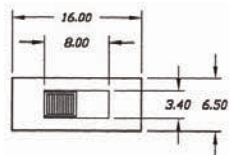

P.C. MOUNTING

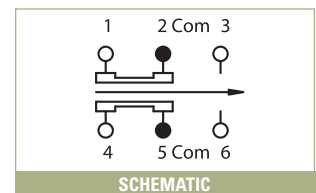

SCHEMATIC

Model No.	L
EG2201	3
EG2201A	6
EG2201B	9
EG2201C	12
EG2201D	4.5

TACT SWITCHES

NAVIGATION SWITCHES

PUSHBUTTON SWITCHES

TOGGLE SWITCHES

ROCKER SWITCHES

SLIDE SWITCHES

SNAP-ACTION SWITCHES

DIP SWITCHES

KEYLOCK SWITCHES

ROTARY SWITCHES

DETECTOR SWITCHES

CAP OPTIONS



SERIES EG SWITCHES

SLIDE SWITCHES

TACT SWITCHES

NAVIGATION SWITCHES

PUSHBUTTON SWITCHES

TOGGLE SWITCHES

ROCKER SWITCHES

SLIDE SWITCHES

SNAP-ACTION SWITCHES

DIP SWITCHES

KEYLOCK SWITCHES

ROTARY SWITCHES

DETECTOR SWITCHES

CAP OPTIONS

EG 2202



Model No.	L
EG2202	5
EG2202A	7.5
EG2202B	9

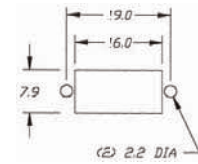
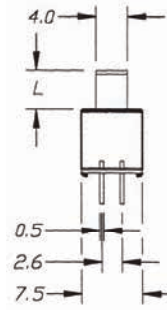
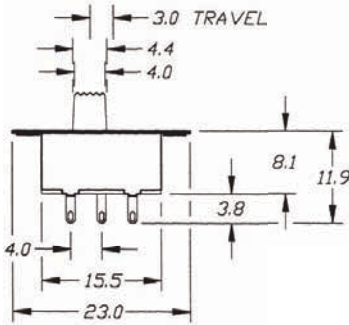
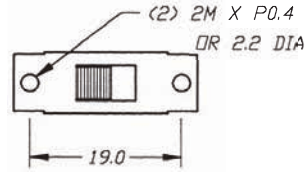

P.C. MOUNTING

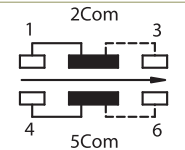

SCHEMATIC

EG 2205



Model No.	L
EG2205	4
EG2205A	2

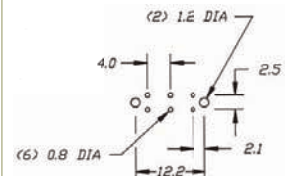
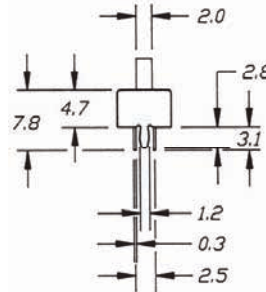
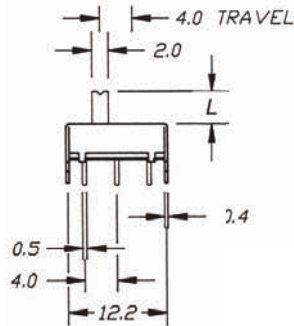
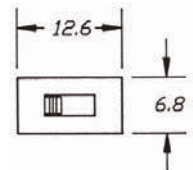

P.C. MOUNTING

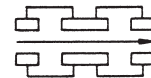

SCHEMATIC

EG 2207

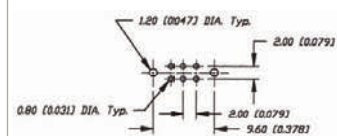
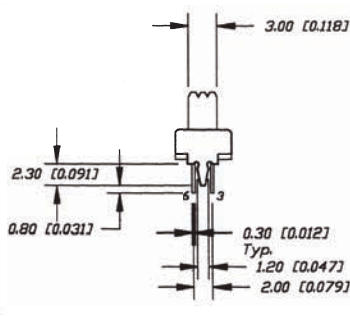
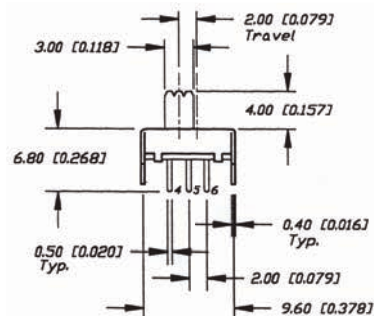
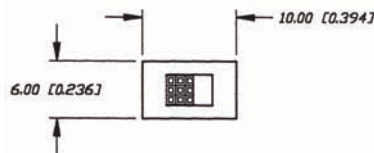

P.C. MOUNTING

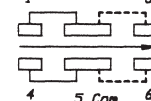

SCHEMATIC



EG 2208



Model No.	L
EG2208	4
EG2208A	6

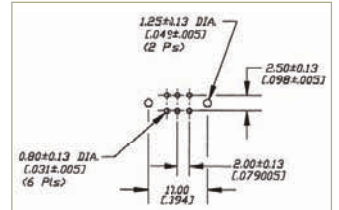
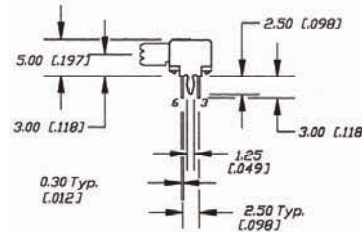
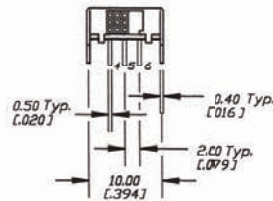
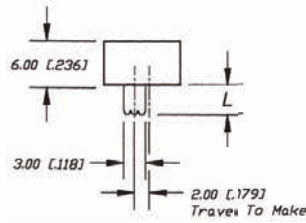

P.C. MOUNTING

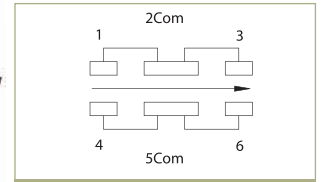

SCHEMATIC

EG 2209



Model No.	L
EG2209	2
EG2209A	4

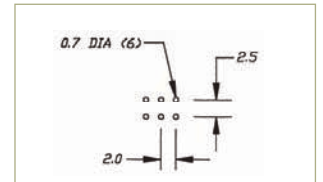
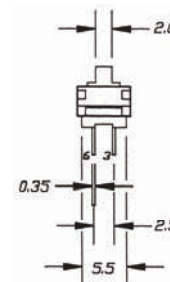
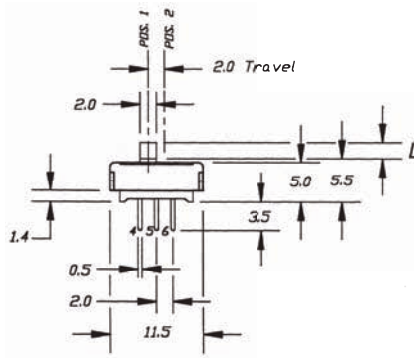
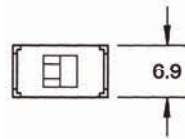

P.C. MOUNTING

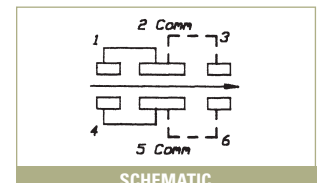

SCHEMATIC

EG 2210

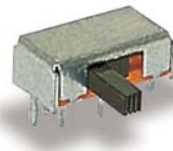

Model No.	L
EG2210	6
EG2210A	4
EG2210D	2

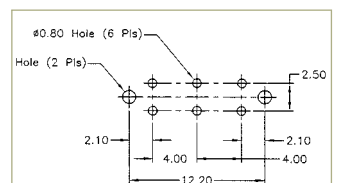
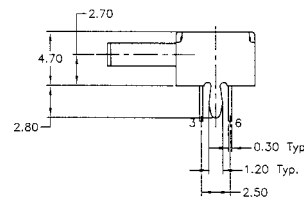
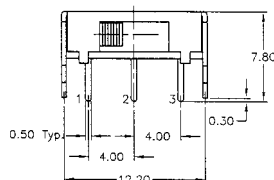
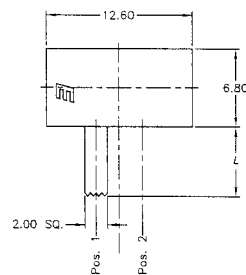

P.C. MOUNTING

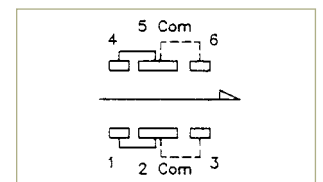

SCHEMATIC

TACT SWITCHES
 NAVIGATION SWITCHES
 PUSHBUTTON SWITCHES
 TOGGLE SWITCHES
 ROCKER SWITCHES
 SLIDE SWITCHES
 SNAP-ACTION SWITCHES
 DIP SWITCHES
 KEYLOCK SWITCHES
 ROTARY SWITCHES
 DETECTOR SWITCHES
 CAP OPTIONS



SERIES EG SWITCHES

SLIDE SWITCHES

TACT SWITCHES

NAVIGATION SWITCHES

PUSHBUTTON SWITCHES

TOGGLE SWITCHES

ROCKER SWITCHES

SLIDE SWITCHES

SNAP-ACTION SWITCHES

DIP SWITCHES

KEYLOCK SWITCHES

ROTARY SWITCHES

DETECTOR SWITCHES

CAP OPTIONS

EG 2211

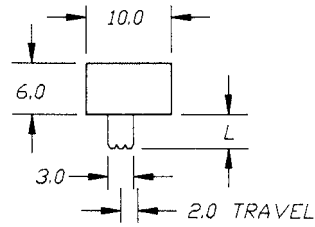

Model No.	L
EG2211	4
EG2211A	2

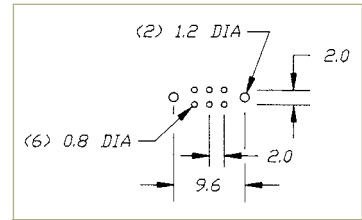
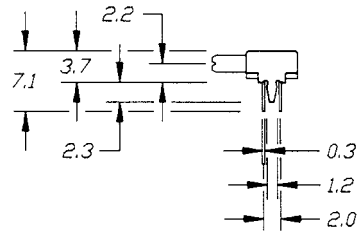
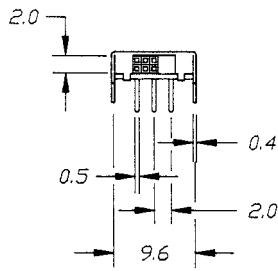

P.C. MOUNTING

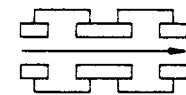

SCHEMATIC

EG 2214

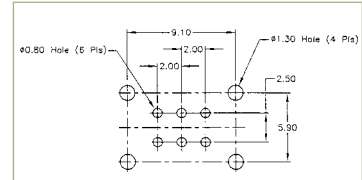
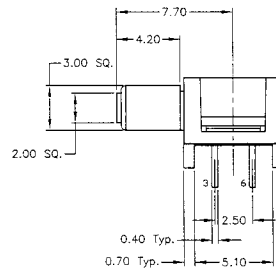
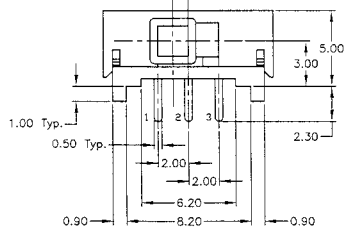
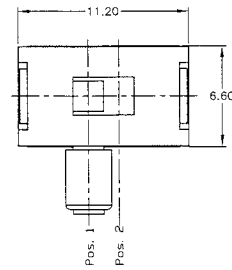

P.C. MOUNTING

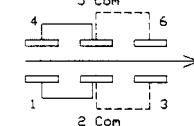

SCHEMATIC

EG 2215

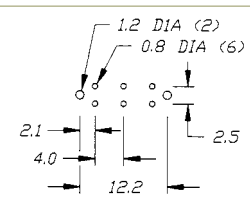
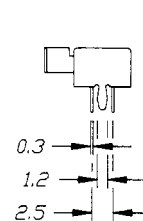
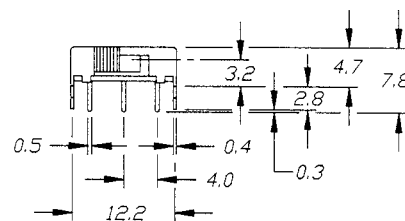
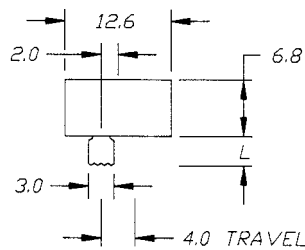

P.C. MOUNTING

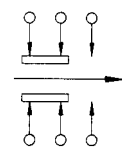

SCHEMATIC

Model No.	L
EG2215	3.5
EG2215A	6



EG 2219

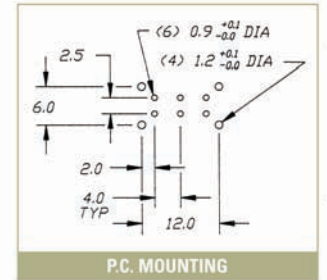
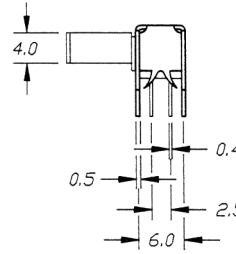
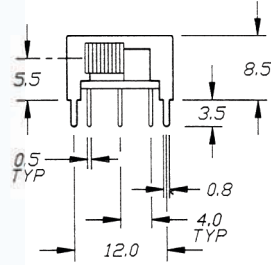
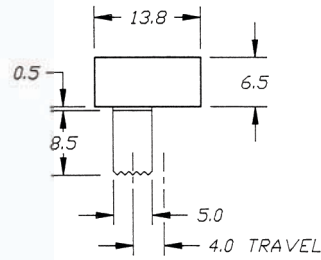

P.C. MOUNTING

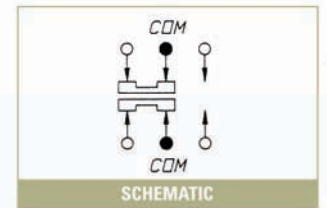

SCHEMATIC

EG 2301



Model No.	L
EG2301	3
EG2301A	6
EG2301B	9
EG2301C	12

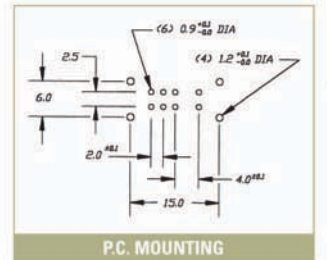
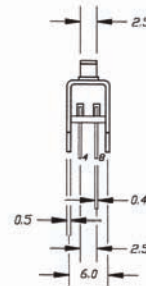
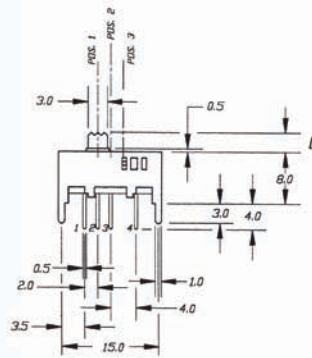
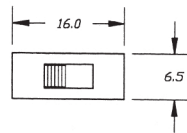

P.C. MOUNTING

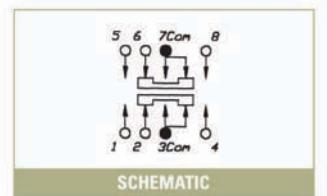

SCHEMATIC

TACT SWITCHES
 NAVIGATION SWITCHES
 PUSHBUTTON SWITCHES
 TOGGLE SWITCHES
 ROCKER SWITCHES
 SLIDE SWITCHES
 SNAP-ACTION SWITCHES
 DIP SWITCHES
 SWITCHES
 SWITCHES
 OPTIONS



SERIES EG SWITCHES

SLIDE SWITCHES

TACT SWITCHES

NAVIGATION SWITCHES

PUSHBUTTON SWITCHES

TOGGLE SWITCHES

ROCKER SWITCHES

SLIDE SWITCHES

SNAP-ACTION SWITCHES

DIP SWITCHES

KEYLOCK SWITCHES

ROTARY SWITCHES

DETECTOR SWITCHES

CAP OPTIONS

EG 2305



Model No.	L
EG2305	4
EG2305A	2

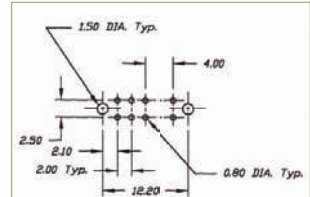
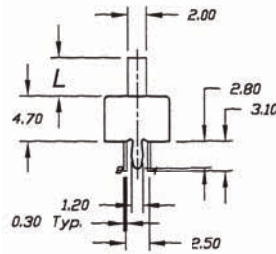
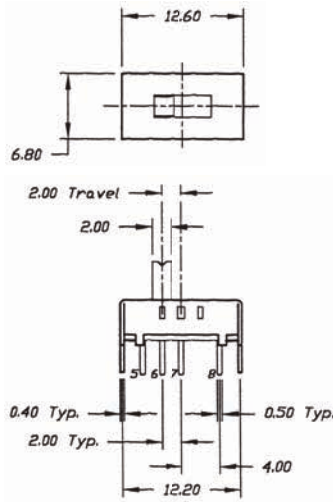

P.C. MOUNTING

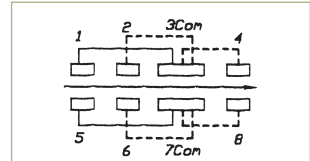

SCHEMATIC

EG 2308



Model No.	L
EG2308	4
EG2308A	6

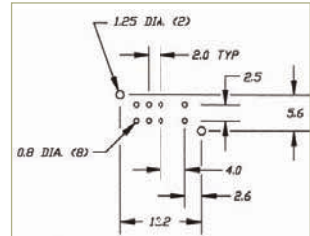
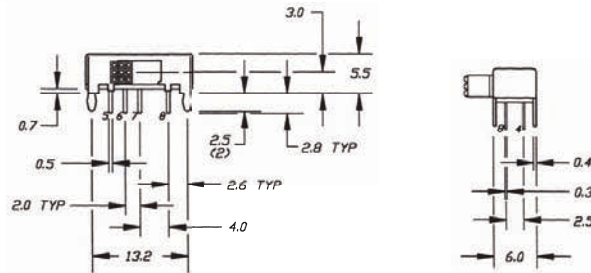
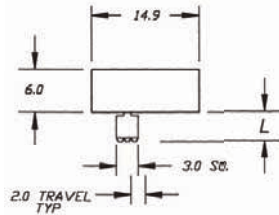

P.C. MOUNTING

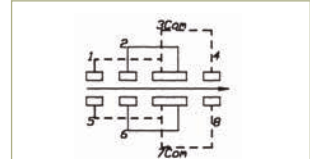

SCHEMATIC

EG 2310



Model No.	L
EG2310	6
EG2310A	4

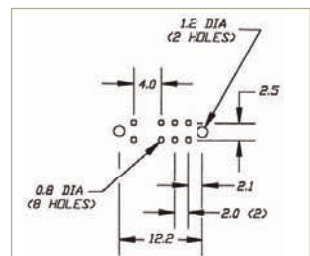
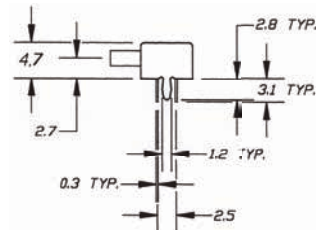
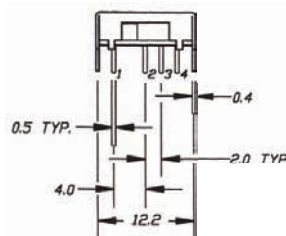
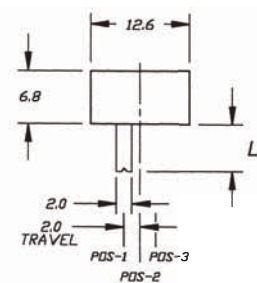

P.C. MOUNTING

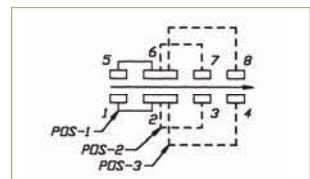

SCHEMATIC



EG 2315



Model No.	L
EG2315	3.5
EG2315A	6

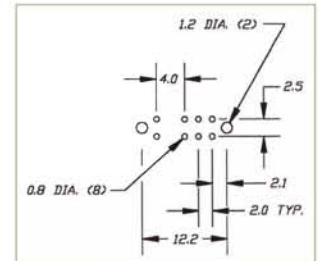
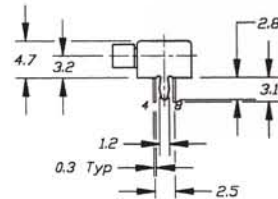
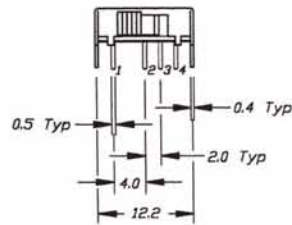
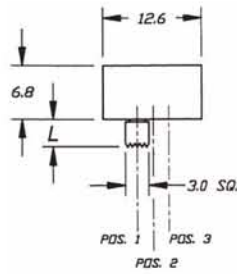

P.C. MOUNTING

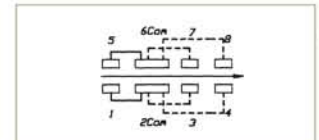

SCHEMATIC

EG 2319

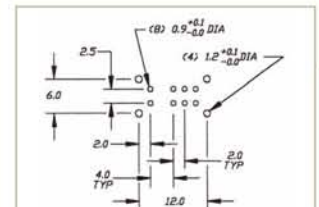
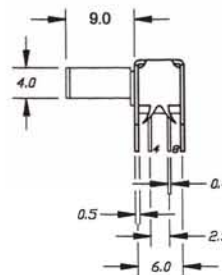
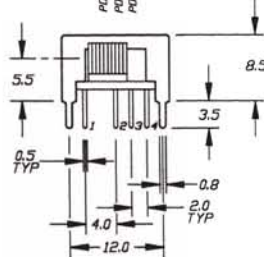
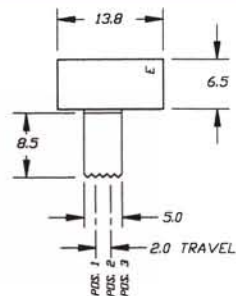

P.C. MOUNTING

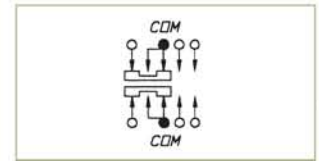

SCHEMATIC

EG 2322

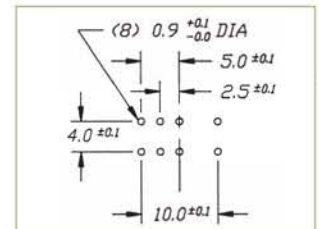
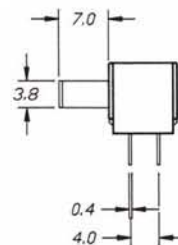
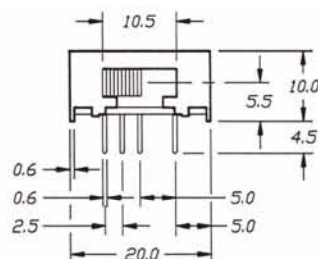
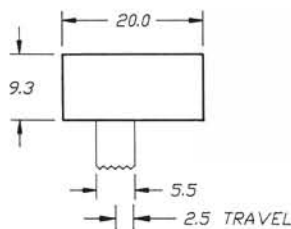

P.C. MOUNTING

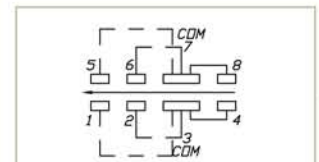

SCHEMATIC

TACT SWITCHES
 NAVIGATION SWITCHES
 PUSHBUTTON SWITCHES
 TOGGLE SWITCHES
 ROCKER SWITCHES
 SLIDE SWITCHES
 SNAP-ACTION SWITCHES
 DIP SWITCHES
 KEYLOCK SWITCHES
 ROTARY SWITCHES
 DETECTOR SWITCHES
 CAP OPTIONS



SERIES EG SWITCHES

SLIDE SWITCHES

TACT SWITCHES

NAVIGATION SWITCHES

PUSHBUTTON SWITCHES

TOGGLE SWITCHES

ROCKER SWITCHES

SLIDE SWITCHES

SNAP-ACTION SWITCHES

DIP SWITCHES

KEYLOCK SWITCHES

ROTARY SWITCHES

DETECTOR SWITCHES

CAP. OPTIONS

EG 2323

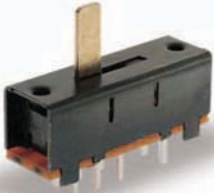

Model No.	Mtg. Hole
EG2323	None
EG2323A	M2.6 x P0.45

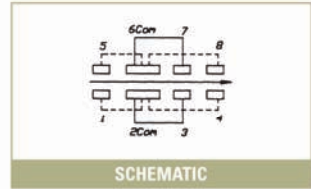
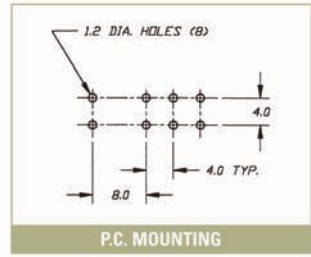
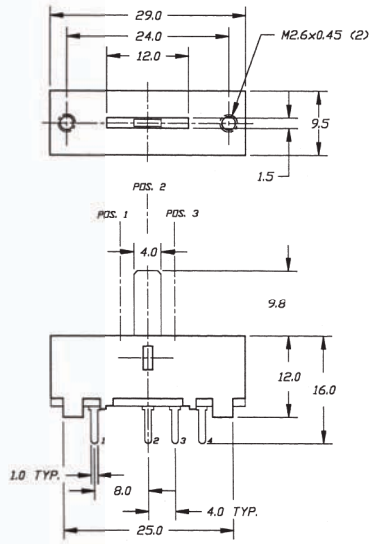

EG 2325



Model No.	L
EG2325	2
EG2325A	6

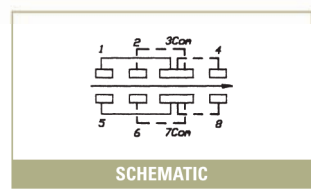
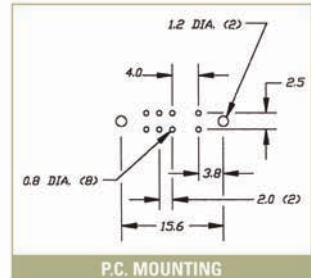
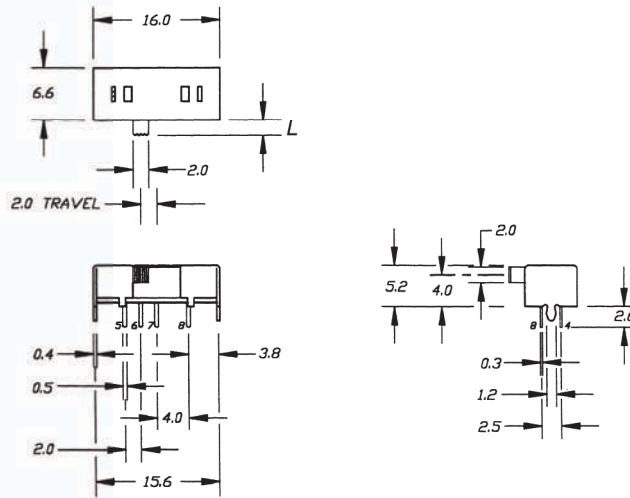



EG 2601

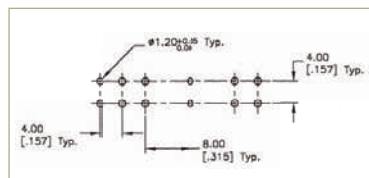
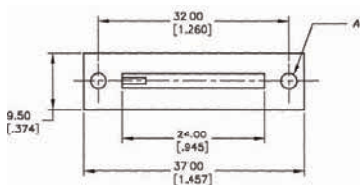
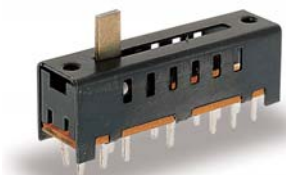

P.C. MOUNTING

Model No.	L	"A"
EG2601	9.8	None
EG2601A	9.8	M2.6 x P0.45
EG2601B	6.5	M2.6 x P0.45
EG2601C	6.5	None

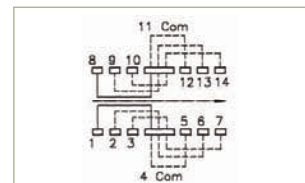
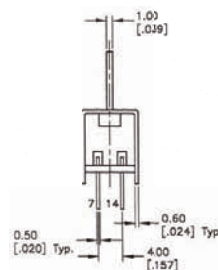
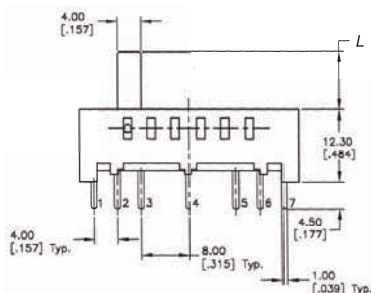

SCHEMATIC

EG 4208

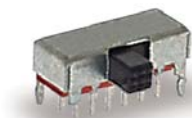

Model No.	L
EG4208	4
EG4208A	6

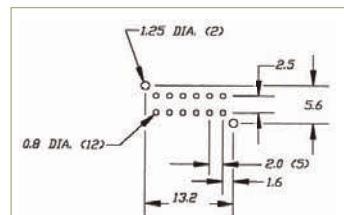
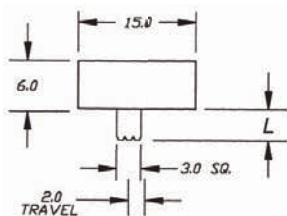

P.C. MOUNTING

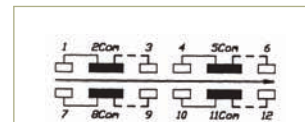
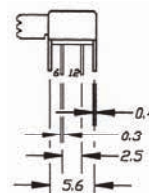
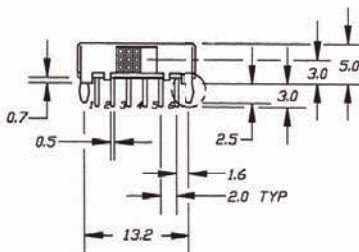

SCHEMATIC

EG 4311

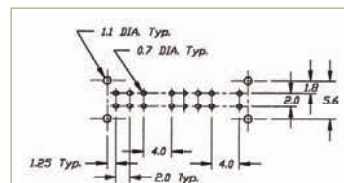
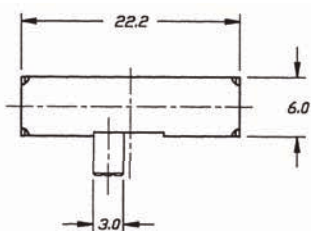

P.C. MOUNTING

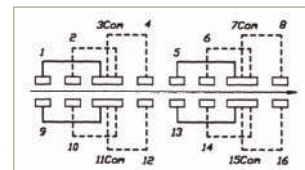
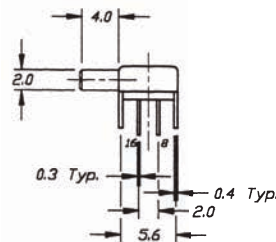
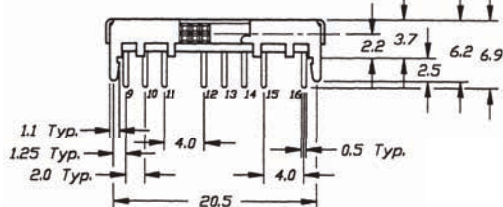

SCHEMATIC



SERIES EG SWITCHES

SLIDE SWITCHES

TACT SWITCHES

NAVIGATION SWITCHES

PUSHBUTTON SWITCHES

TOGGLE SWITCHES

ROCKER SWITCHES

SLIDE SWITCHES

SNAP-ACTION SWITCHES

DIP SWITCHES

KEYLOCK SWITCHES

ROTARY SWITCHES

DETECTOR SWITCHES

CAP OPTIONS

EG 4319

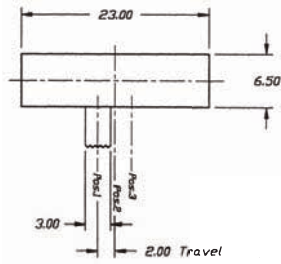
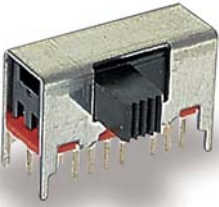

Model No.	L
EG4319	5
EG4319A	6

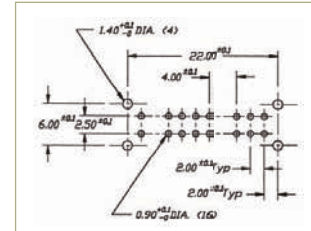
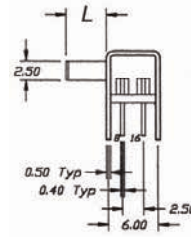
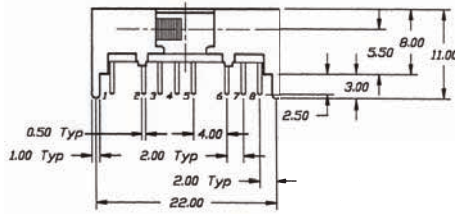

P.C. MOUNTING

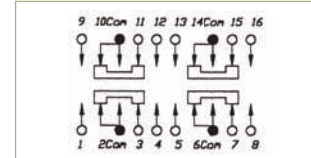

SCHEMATIC

EG 6201

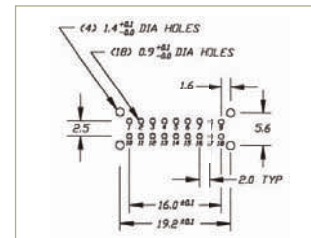
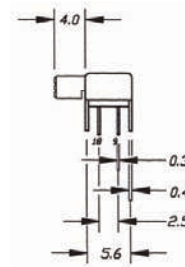
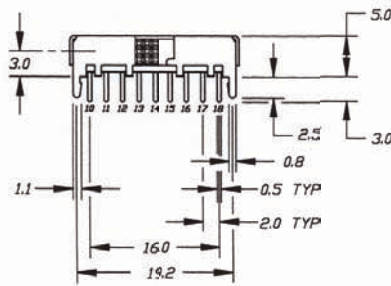
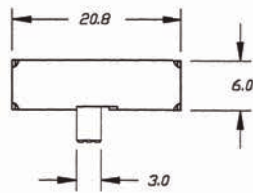

P.C. MOUNTING

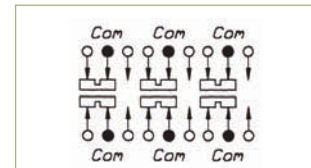

SCHEMATIC