

Cell Type CR2430v Specifications

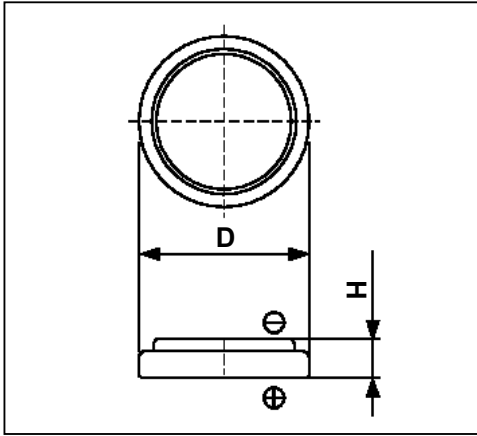

Nominal Voltage (V)		3
Nominal Capacity (mAh) ^{*1}		300
Standard Discharge Current (mA)		0.3
Operating Temperature Range (°C)		-20 ~ +70
Max. Dimensions (mm)	Diameter (D)	24.5
	Height (H)	3.0
Weight (g)		4.3

*1 Nominal capacity is determined at an end voltage of 2.0V when the battery is allowed to discharge at a standard current level at +23°C.

Typical Characteristics

Discharge Characteristics of CR2430

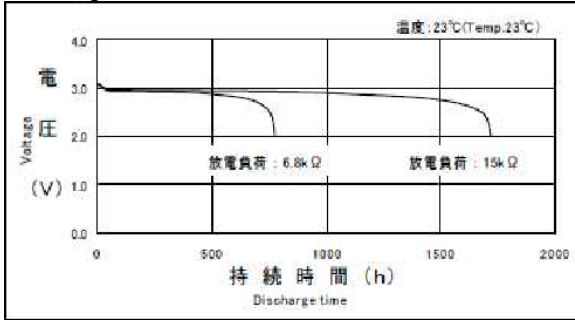

Temperature Characteristics of CR2430

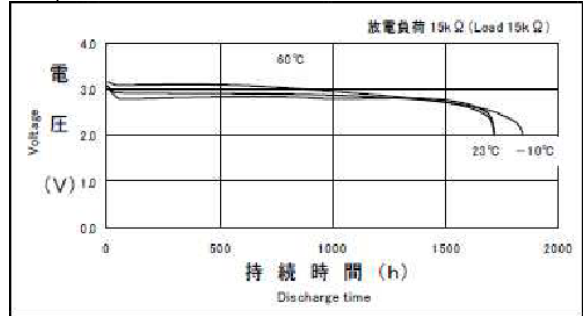

Discharge Load vs. Open Voltage of CR2430 (DOD40%)

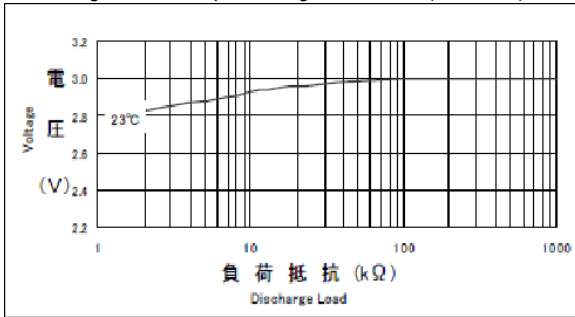

Discharge Load vs. Cell Capacity of CR2430

