

OSTAR - Projection

Lead (Pb) Free Product - RoHS Compliant

LE AB H3AB

Vorläufige Daten / Preliminary Data

Abgekündigt nach OS-PD-2008-008
Obsolete acc. to OS-PD-2008-008

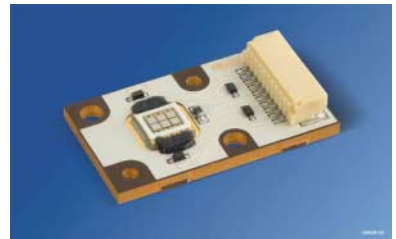

Besondere Merkmale

- **Gehäusertyp:** Kompakte Lichtquelle in Multi-Chip on Board Technologie; planvergossen
- **Besonderheit des Bauteils:** extrem hohe Helligkeit dank Oberflächenemission und niedrigem R_{th}
Vorbereitet für den Einsatz mit zus. Optik
- **Wellenlänge:** 617 nm (amber), 464 nm (blau)
- **Abstrahlwinkel:** Lambertischer Strahler (120°)
- **Abstrahlende Fläche:** typ. 2 x 1 mm² (blau); 4 x 1 mm² (amber)
- **Technologie:** Thinfilm InGaAIP (amber), ThinGaN[®] (blau)
- **Leuchtdichte:** 26,0*10⁶ cd/m² (amber), 6,7*10⁶ cd/m² (blau)
- **Montierbarkeit:** verschraubbar
- **Stecker:** 10 Pin JST SM10B-SRSS-TB
- **ESD-Festigkeit:** ESD-sicher bis 2 kV nach JESD22-A114-D
- **Verpackungseinheit:** 50 St. pro Box = Verpackungseinheit

Anwendungen

- Projektoren
- Medizintechnik: Operationslampen
- Mikroskopbeleuchtung
- Scheinwerfer
- Verkehrszeichen
- Hochwertige Blitzlichter

Features

- **package:** compact lightsource in multi chip on board technology; planar sealed
- **feature of the device:** outstanding luminance due to pure surface emission and low R_{th}
prepared for additional optics
- **wavelength:** 617 nm (amber), 464 nm (blue)
- **viewing angle:** Lambertian Emitter (120°)
- **light emitting surface:** typ. 2 x 1 mm² (blue); 4 x 1 mm² (amber)
- **technology:** Thinfilm InGaAIP (amber), ThinGaN[®] (blue)
- **Luminance:** 26.0*10⁶ cd/m² (amber), 6.7*10⁶ cd/m² (blue)
- **mounting methode:** screw holes
- **connector:** 10 Pin JST SM10B-SRSS-TB
- **ESD-withstand voltage:** up to 2 kV acc. to JESD22-A114-D
- **method of packing:** 50 pcs. per tray = packing unit

Applications

- projectors
- medical lighting: surgery light
- microscope illumination
- spotlights
- VMS (variable message signs)
- high end strobe light

Typ Type	Emissionsfarbe Color of Emission	Lichstärke pro Farbe ¹⁾ Seite 17 Luminous Intensity per Color ¹⁾ page 17 $I_F = 1000 \text{ mA}$ $I_V \text{ (cd)}$			
		amber		blue	
		min.	typ.	min.	typ.
LE AB H3AB	amber blue	56	105	7.1	13

Bestellinformation Ordering Information

Typ Type	Emissionsfarbe Color of Emission	Lichtfluss pro Farbe ²⁾³⁾ Seite 17 Luminous Flux per Color ²⁾³⁾ page 17 $I_F = 1000 \text{ mA}$ $\Phi_V \text{ (lm)}$			
		amber		blue	
		min.	typ.	min.	typ.
LE AB H3AB	amber blue	(168)	(326)	(21.3)	(40)

Bestellinformation Ordering Information

Typ Type	Bestellnummer Ordering Code
■ LE AB H3AB-JBLA-1+EFWF-23	Q65110A6243
LE_ACC_SHR_10V_SR	Q65110A4679 (Connector)*

■ Abgekündigt nach OS-PD-2008-008 - wird durch LE AB H3WB ersetzt werden
 Obsolete acc. to OS-PD-2008-008 - will be replaced by LE AB H3WB
 Letzte Bestellung / Last Order: 2009-01-10
 Letzte Lieferung / Last Delivery: 2009-07-10

Anm: Die oben genannten Typbezeichnungen umfassen die bestellbaren Selektionen. Diese bestehen aus einer Helligkeitsgruppe. Es wird nur eine einzige Helligkeitsgruppe und Farbgruppe pro Verpackungsbox geliefert.

* Zum Zweck der Bemusterung kann in kleinen Stückzahlen der konfektionierte JST-Gegenstecker mit Kabel angefordert werden.

Note: The above Type Numbers represent the order groups which includes only one brightness group per color and tray. Only one group will be shipped on each tray.

*In small amounts for the purpose of sampling the corresponding connector assembled with cable can be ordered

Grenzwerte
Maximum Ratings

Bezeichnung Parameter	Symbol Symbol	Werte Values		Einheit Unit
		amber	blue	
Betriebstemperatur* Operating temperature range*	$T_{\text{board, op}}$	- 40 ... + 85		°C
Lagertemperatur Storage temperature range	$T_{\text{board, stg}}$	- 40 ... + 85		°C
Sperrschichttemperatur Junction temperature	T_j	125		°C
Durchlassstrom pro Chip DC Forward current per chip DC ($T_{\text{board}}=25^\circ\text{C}$)	I_F	1000		mA
Stoßstrom pro Chip DC Surge current per chip DC $t \leq 10 \mu\text{s}$, $D = 0.1$; $T_A=25^\circ\text{C}$	I_{FM}	2000		mA
Sperrspannung pro Chip DC Reverse voltage per chip DC ($T_{\text{board}}=25^\circ\text{C}$)	V_R	0.5		V
Sperrstrom Reverse current $V_R = 0.5 \text{ V}$	I_R	10		mA
Leistungsaufnahme pro Farbe Power consumption per Color ($T_{\text{board}}=25^\circ\text{C}$)	P_{tot}	15.5	10	W

* Eine Betauung des Moduls muss vermieden werden.
Condensation on the module has to be avoided.

Kennwerte
Characteristics

Bezeichnung Parameter	Symbol Symbol	Werte Values	Einheit Unit
Wärmewiderstand des gesamten Moduls Thermal resistance of the module Sperrschicht / Bodenplatte Junction / base plate	$R_{\text{th JB}}$	2.0 (typ.)	K/W

Kennwerte
Characteristics
 $(T_{\text{board}} = 25\text{ °C})$

Bezeichnung Parameter	Symbol Symbol	Werte Values		Einheit Unit
		amber	blau	
Wellenlänge des emittierten Lichtes Wavelength at peak emission $I_F = 1000\text{ mA}$	(typ.) λ_{peak}	627	460	nm
Dominantwellenlänge ^{4) Seite 17} Dominant wavelength ^{4) page 17} $I_F = 1000\text{ mA}$	(min.) λ_{dom} (typ.) λ_{dom} (max.) λ_{dom}	613 617 625	456 464 469	nm nm nm
Spektrale Bandbreite bei 50 % $I_{V\text{rel max}}$ Spectral bandwidth at 50 % $I_{V\text{rel max}}$ $I_F = 1000\text{ mA}$	(typ.) $\Delta\lambda$	24	27	nm
Abstrahlwinkel bei 50 % I_V (Vollwinkel) Viewing angle at 50 % I_V	(typ.) 2φ	120	120	Grad deg.
Durchlassspannung pro Chip ^{5) Seite 17} Forward voltage per Chip ^{5) page 17} $I_F = 1000\text{ mA}$	(min.) V_F (typ.) V_F (max.) V_F	2.25 2.8 3.85	3.2 4.0 5.0	V V V
Temperaturkoeffizient von λ_{peak} Temperature coefficient of λ_{peak} $I_F = 1000\text{ mA}; -10\text{ °C} \leq T \leq 100\text{ °C}$	(typ.) $TC_{\lambda_{\text{peak}}}$	0.14	0.05	nm/K
Temperaturkoeffizient von λ_{dom} Temperature coefficient of λ_{dom} $I_F = 1000\text{ mA}; -10\text{ °C} \leq T \leq 100\text{ °C}$	(typ.) $TC_{\lambda_{\text{dom}}}$	0.08	0.02	nm/K
Temperaturkoeffizient von V_F pro Chip Temperature coefficient of V_F per chip $I_F = 1000\text{ mA}; -10\text{ °C} \leq T \leq 100\text{ °C}$	(typ.) TC_V	- 2.5	- 4.5	mV/K
Optischer Wirkungsgrad ohne Linse Optical efficiency without Lens $I_F = 1000\text{ mA}$	(typ.) η_{opt}	29	5.2	lm/W
Abstrahlende Fläche Radiating Surface	(typ.) A_{Color}	4 x 1	2 x 1	mm ²
Leuchtdichte Luminance $I_F = 1000\text{ mA}$	(typ.) L_V	$26.0 \cdot 10^6$	$6.7 \cdot 10^6$	cd/m ²

SMD NTC Thermistors
SMD NTC Thermistors

R_{25} [Ω]	No. of R/T characteristic s*	$B_{25/50}$ [K]	$B_{25/85}$ [K]	Resistance Tolerance $\Delta R_N/R_N$	B value Tolerance $\Delta B/B$	$P_{NTC,max,25}$ [mW]
10k	EPCOS 8502	3940	3980	± 5%	± 3%	180

* for further information please visit www.epcos.com

$$R_T = R_N \cdot e^{B \cdot \left(\frac{1}{T} - \frac{1}{T_N} \right)}$$

R_T = NTC resistance in Ω at temperature T in K
 R_N = NTC resistance in Ω at rated temperature T_N
in K ($T_N = 298$ K for test condition)
T, T_N = temperature in K
e = base of the natural logarithm (e = 2.71828)

B = B value, material specific constant of the NTC thermistor

$$B = B_{N/T} = \frac{T \cdot T_N}{T - T_N} \cdot \ln \frac{R_N}{R_T}$$

Typische Thermistor Kennlinie^{2) 7) Seite 17}
Typical Thermistor Graph^{2) 7) page 17}

$I_F = f(V_F); T_{board} = 25\text{ °C}$

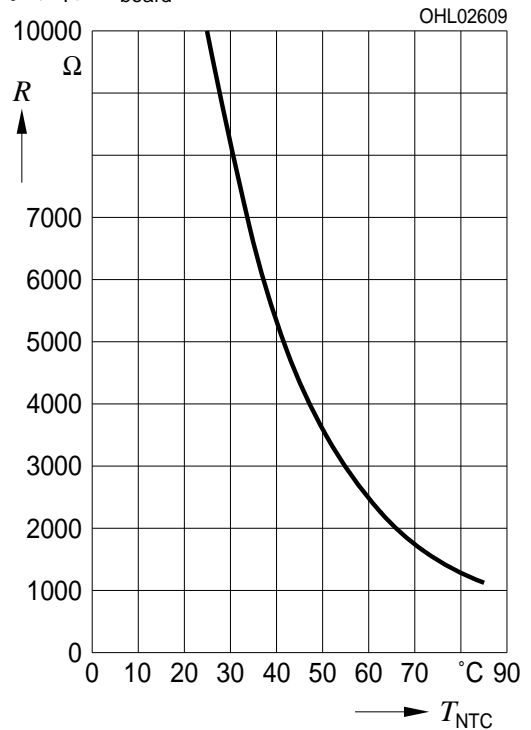

Helligkeits-Gruppierungsschema Brightness Groups

	Helligkeitsgruppe Brightness Group	Lichtstärke ^{1) Seite 17} Luminous Intensity ^{1) page 17} I_V (cd)	Lichtstrom ^{2) 3) Seite 17} Luminous Flux ^{2) 3) page 17} Φ_V (lm)
amber	JB	56 ... 71	190 (typ.)
	KA	71 ... 90	240 (typ.)
	KB	90 ... 112	300 (typ.)
	LA	112 ... 140	380 (typ.)
blue	EW	7.1 ... 11.2	25.0 (typ.)
	FW	11.2 ... 18.0	45.0 (typ.)

Anm.: Die Standardlieferform von Serientypen beinhaltet eine Familiengruppe. Diese besteht aus nur wenigen Helligkeitsgruppen. Einzelne Helligkeitsgruppen sind nicht bestellbar.

Note: The standard shipping format for serial types includes a family group of only a few individual brightness groups. Individual brightness groups cannot be ordered.

Wellenlängengruppen (Dominantwellenlänge)^{4) Seite 17} Wavelength Groups (Dominant Wavelength)^{4) page 17}

Gruppe Group	blue	
	min. [nm]	max. [nm]
2	456	462
3	462	469

Gruppenbezeichnung auf Etikett Group Name on Label

Beispiel: KA-1+FW-2

Example: KA-1+FW-2

Helligkeitsgruppe Brightness Group

KA-1+FW-2

Anm.: In einer Verpackungseinheit ist immer nur eine Gruppe für jede Selektion enthalten.

Note: No packing unit ever contains more than one group for each selection.

Relative spektrale Emission^{2) Seite 17}

Relative Spectral Emission^{2) page 17}

$V(\lambda)$ = spektrale Augenempfindlichkeit / Standard eye response curve

$I_{rel} = f(\lambda)$, $T_{board} = 25\text{ °C}$, $I_F = 1000\text{ mA}$

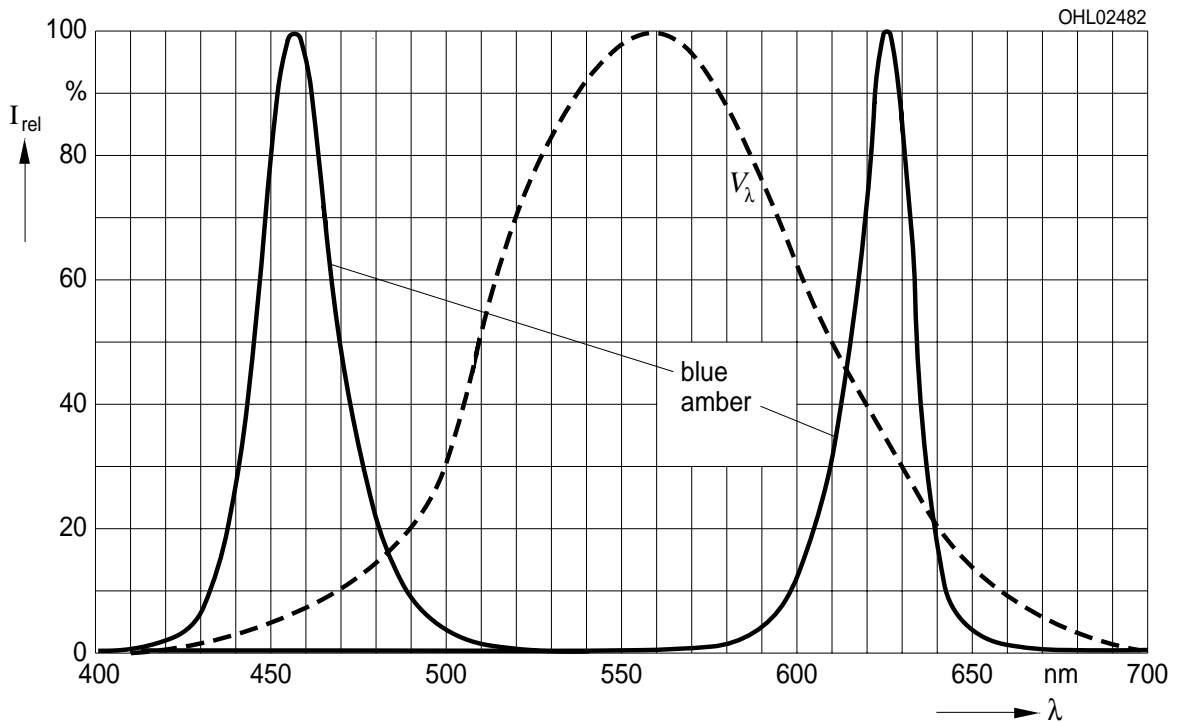

Abstrahlcharakteristik^{2) Seite 17}

Radiation Characteristic^{2) page 17}

$\Phi_{rel} = f(\varphi)$; $T_{board} = 25\text{ °C}$

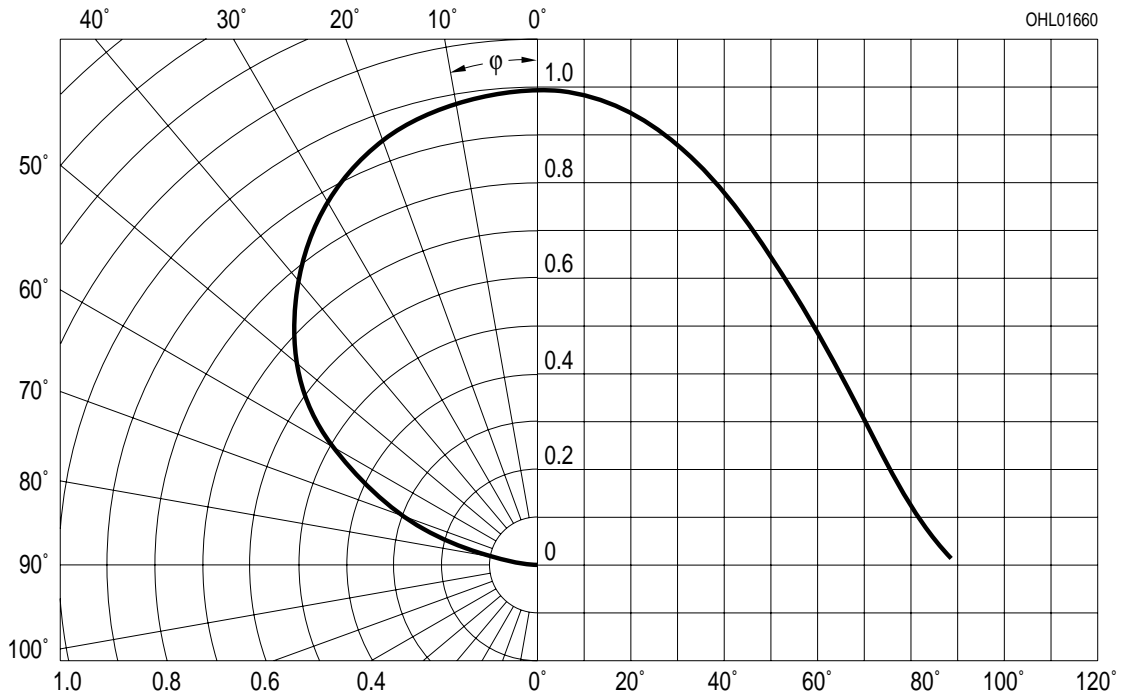

Durchlassstrom (amber)²⁾ Seite 17

Forward Current (amber)²⁾ page 17

$I_F = f(V_F); T_{board} = 25\text{ }^\circ\text{C}$

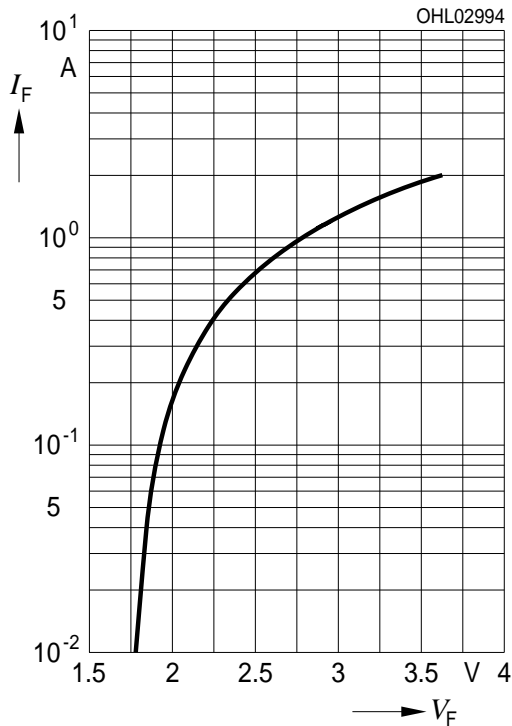

Relative Lichtstärke^{2) 8)} Seite 17

Relative Luminous Intensity^{2) 8)} page 17

$I_V/I_{V(1000\text{ mA})} = f(I_F); T_{board} = 25\text{ }^\circ\text{C}; t_p=1\text{ ms}, D=0,0003$

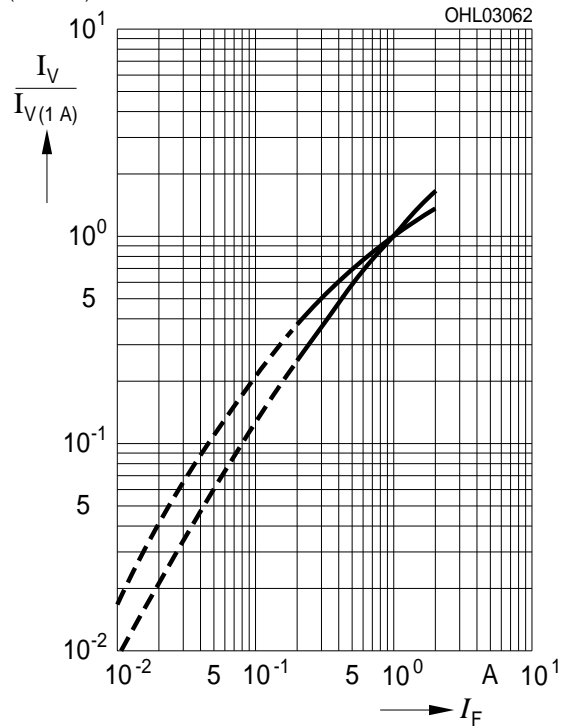

Durchlassstrom (blau)²⁾ Seite 17

Forward Current (blue)²⁾ page 17

$I_F = f(V_F); T_{board} = 25\text{ }^\circ\text{C}$

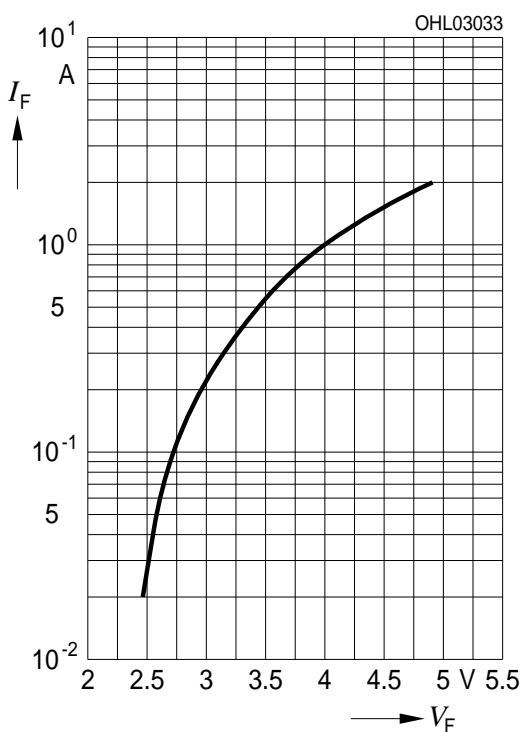

Relative Lichtstärke^{2) 8)} Seite 17

Relative Luminous Intensity^{2) 8)} page 17

$I_V/I_{V(1000\text{ mA})} = f(I_F); T_{board} = 25\text{ }^\circ\text{C}; t_p=1\text{ ms}, D=0,0003$

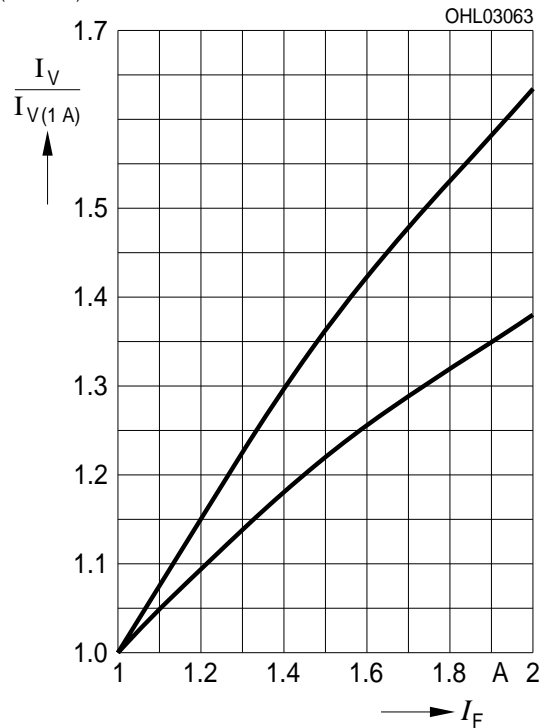

Relative Lichtstärke²⁾ Seite 17

Relative Luminous Intensity²⁾ page 17

$I_V/I_{V(25^\circ\text{C})} = f(T_j); I_F = 1000 \text{ mA}$

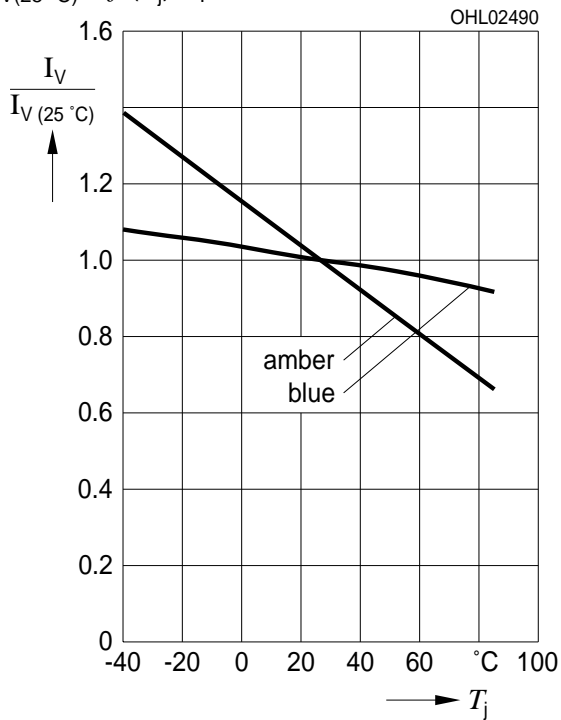

Relative Vorwärtsspannung²⁾ Seite 17

Relative Forward Voltage²⁾ page 17

$\Delta V_F = V_F - V_{F(25^\circ\text{C})} = f(T_j); I_F = 1000 \text{ mA(amber)}$

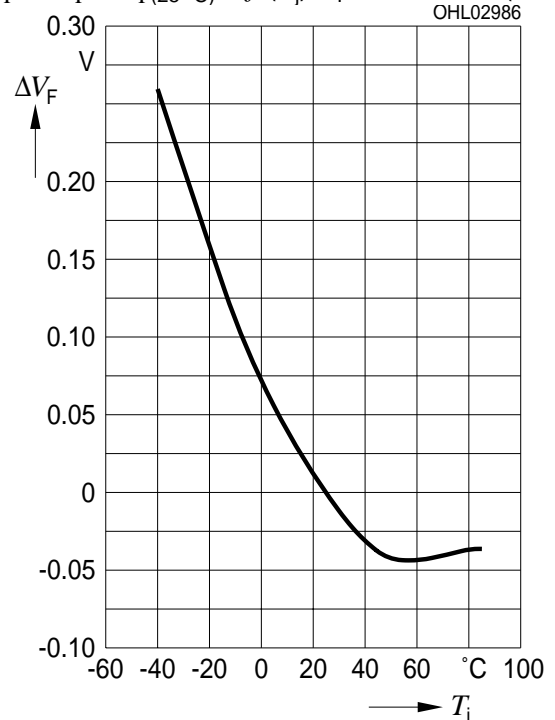

Dominante Wellenlänge²⁾ Seite 17

Dominant Wavelength²⁾ page 17

$\Delta \lambda_{\text{dom}} = f(I_F); T_{\text{board}} = 25^\circ\text{C}$

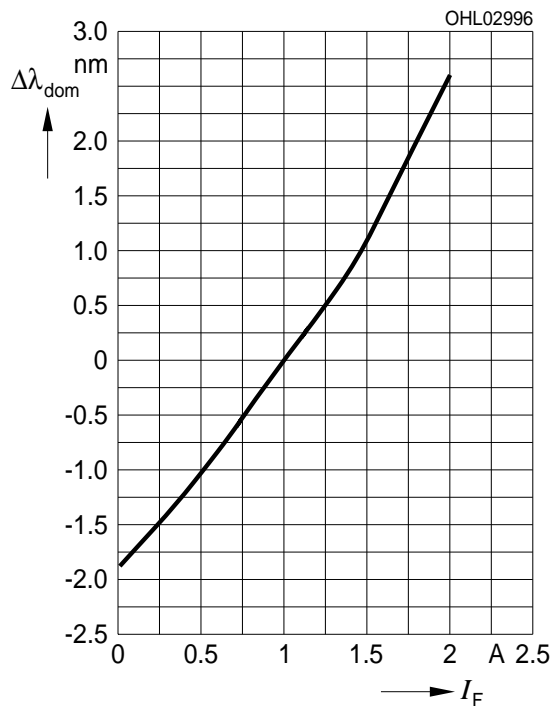

Relative Vorwärtsspannung²⁾ Seite 17

Relative Forward Voltage²⁾ page 17

$\Delta V_F = V_F - V_{F(25^\circ\text{C})} = f(T_j); I_F = 1000 \text{ mA (blue)}$

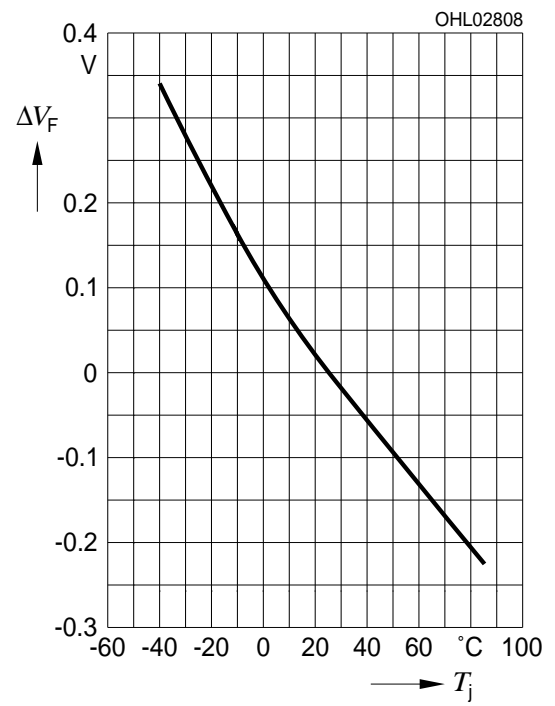

Dominante Wellenlänge²⁾ Seite 17

Dominant Wavelength²⁾ page 17

LB, $\lambda_{\text{dom}} = f(I_F)$; $T_{\text{board}} = 25\text{ }^\circ\text{C}$

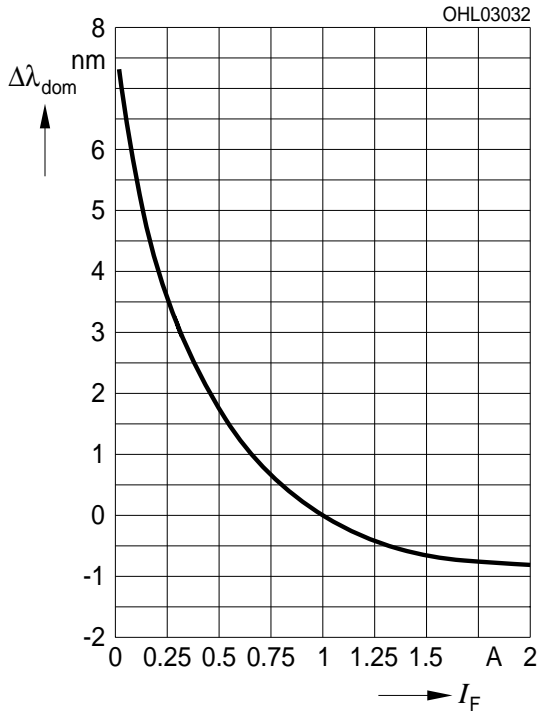

Transient Thermal resistance
Z_{th}* (frequency, DC) for 4 Chips operated

4 Chips operated; $I_F = f(T_S)$, amber

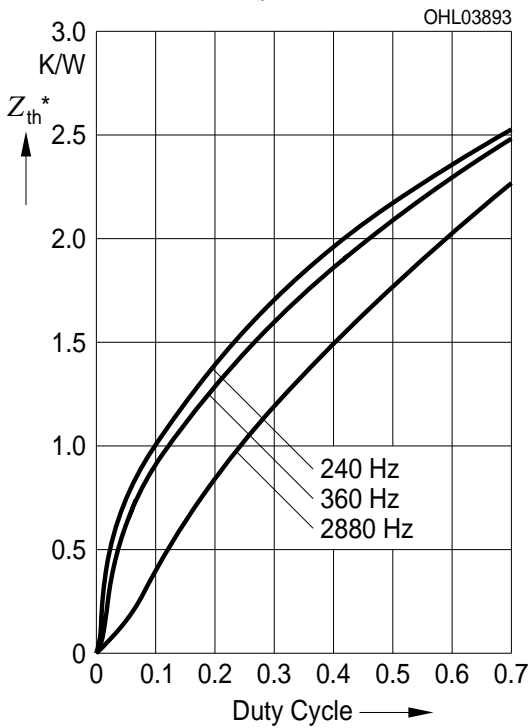

Transient Thermal resistance
Z_{th}* (frequency, DC) for 2 Chips operated

2 Chips operated; $I_F = f(T_S)$, blue

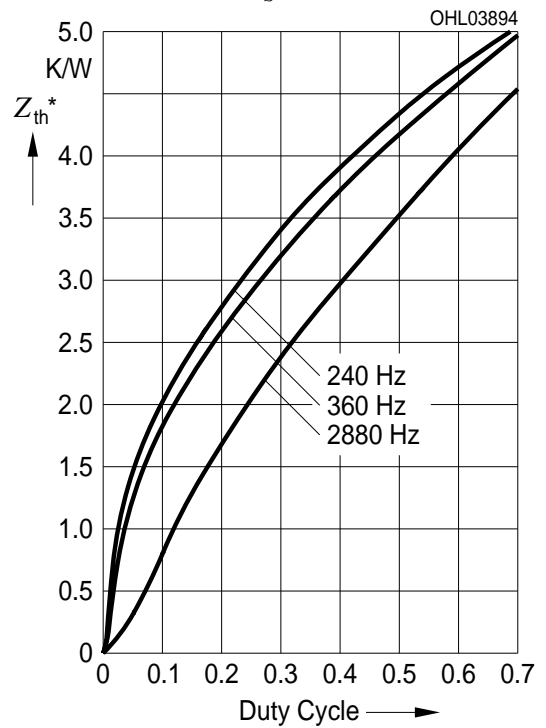

Zulässige Impulsbelastbarkeit $I_F = f(t_p)$
Permissible Pulse Handling Capability

amber Duty cycle $D =$ parameter, $T_{board} = 55\text{ °C}$
 4 chips operated simultaneously in series

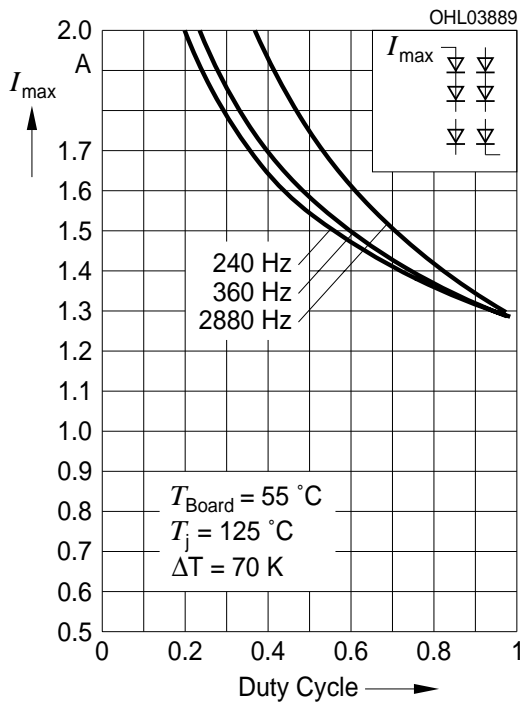

Zulässige Impulsbelastbarkeit $I_F = f(t_p)$
Permissible Pulse Handling Capability

amber Duty cycle $D =$ parameter, $T_{board} = 85\text{ °C}$
 4 chips operated simultaneously in series

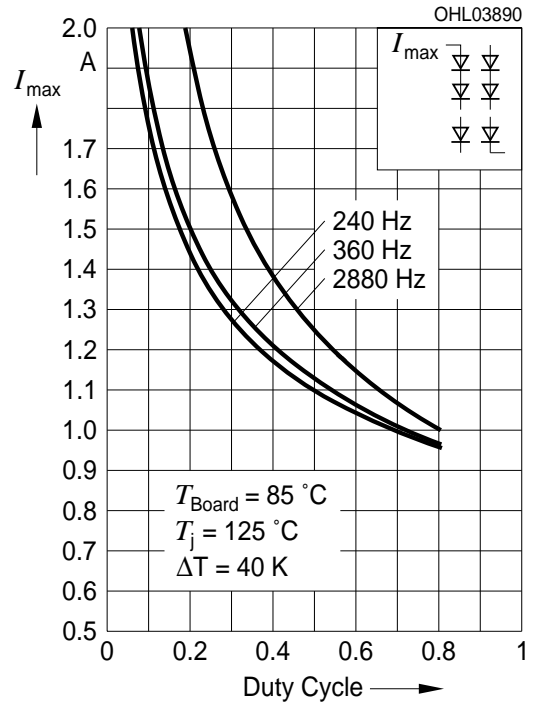

Zulässige Impulsbelastbarkeit $I_F = f(t_p)$
Permissible Pulse Handling Capability

blue: Duty cycle $D =$ parameter, $T_{board} = 55\text{ °C}$
 2 chips operated simultaneously in series

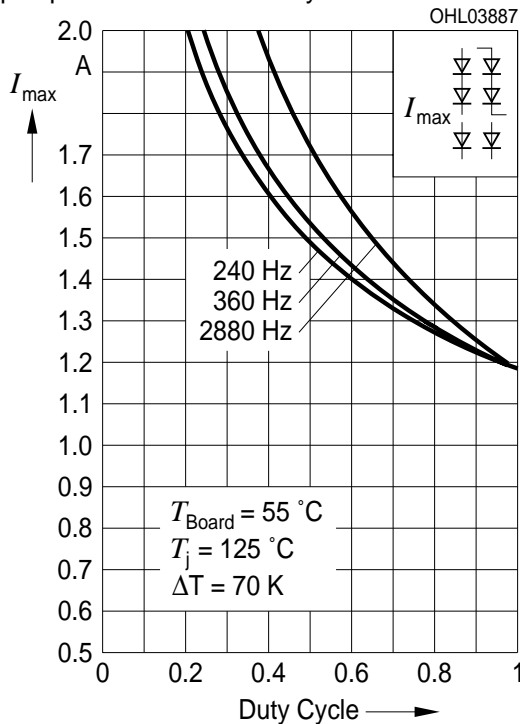

Zulässige Impulsbelastbarkeit $I_F = f(t_p)$
Permissible Pulse Handling Capability

blue: Duty cycle $D =$ parameter, $T_{board} = 85\text{ °C}$
 2 chips operated simultaneously in series

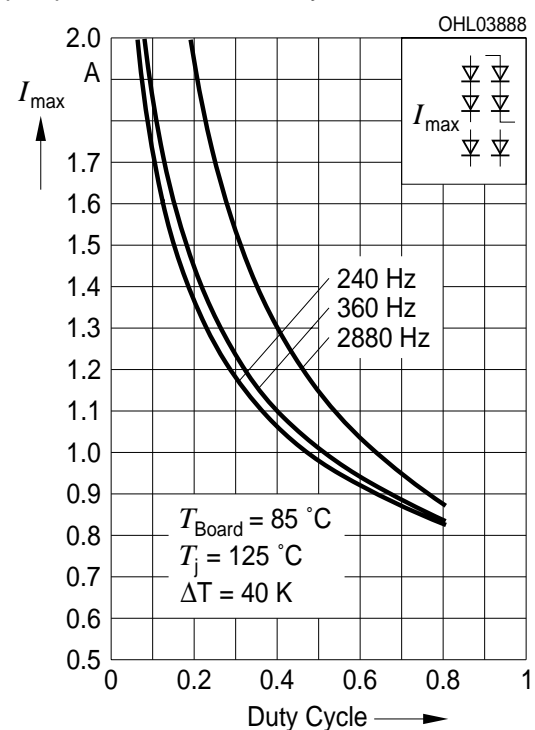

Maßzeichnung⁹⁾ Seite 17
 Package Outlines⁹⁾ page 17

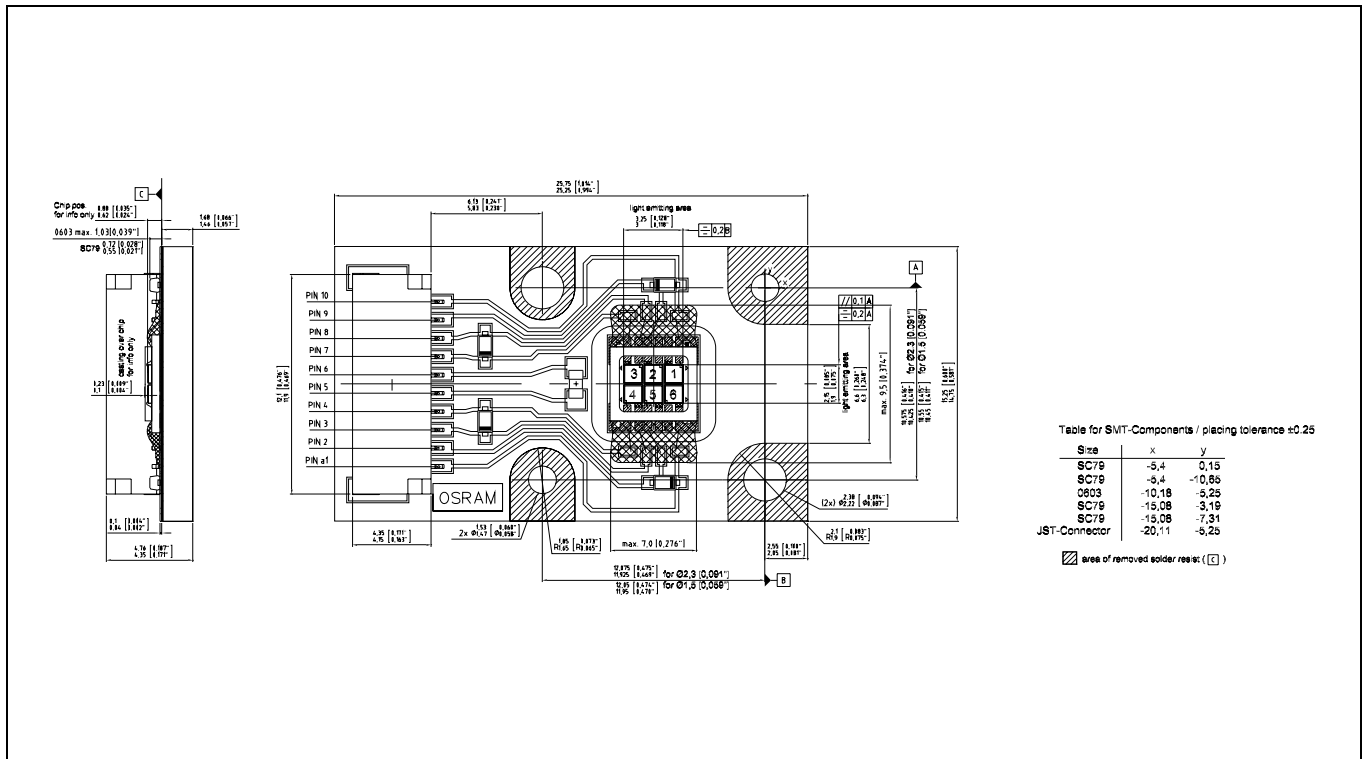

Chip-Position:

- 1: Blue
- 2: Blue
- 3: Amber
- 4: Amber
- 5: Amber
- 6: Amber

Pin-Assignment:

- 1: Anode; Chip 5, 6
- 2: Cathode; Chip 5, 6
- 3: Anode; Chip 4
- 4: Cathode; Chip 4
- 5: NTC
- 6: NTC
- 7: Anode; Chip 3
- 8: Cathode; Chip 3
- 9: Anode; Chip 1, 2
- 10: Cathode; Chip 1, 2

Kathodenkennung:

Cathode mark:

Gewicht / Approx. weight:

Markierung

mark

5.3 g

Verwendeter Stecker / Used male connector on board:

Empfohlene Gegenstecker /

Recommended female connector for power supply:

Kontakt - Pins:

JST SM10B-SRSS-TB (www.jst.com)

JST SHR-10V-S (www.jst.com)

JST SHR-10V-S-B (www.jst.com)

SSH-003T-P0.2 (www.jst.com)

Connecting and disconnecting OSRAM OS Ostar Projection modules

When connecting or disconnecting an Ostar Projection module care has to be taken in order to prevent a damage of the module. The module is equipped with a male connector socket (JST SM 10B-SR SS-TB). As a female connector for power supply a JST SHR-10V-S (without protrusions) or a JST SHR-10V-S-B (with protrusions) with SSH-003T-P0.2 pins is recommended.

When disconnecting the connector the applied pull force must not exceed 17 N * (footnote * A force of 17 N can only be applied dynamically during disconnecting. No constant force must be applied to the connector.) Disconnection of the module during operation or at high temperatures can damage the module. The board temperature must not exceed 40°C during disconnection. During mating operation, mate connectors while holding wires in a bundle on the same axis to the mating axis. For unmating wires must be held in a bundle within 20 degrees to the mating axis (see Fig. for explanation).

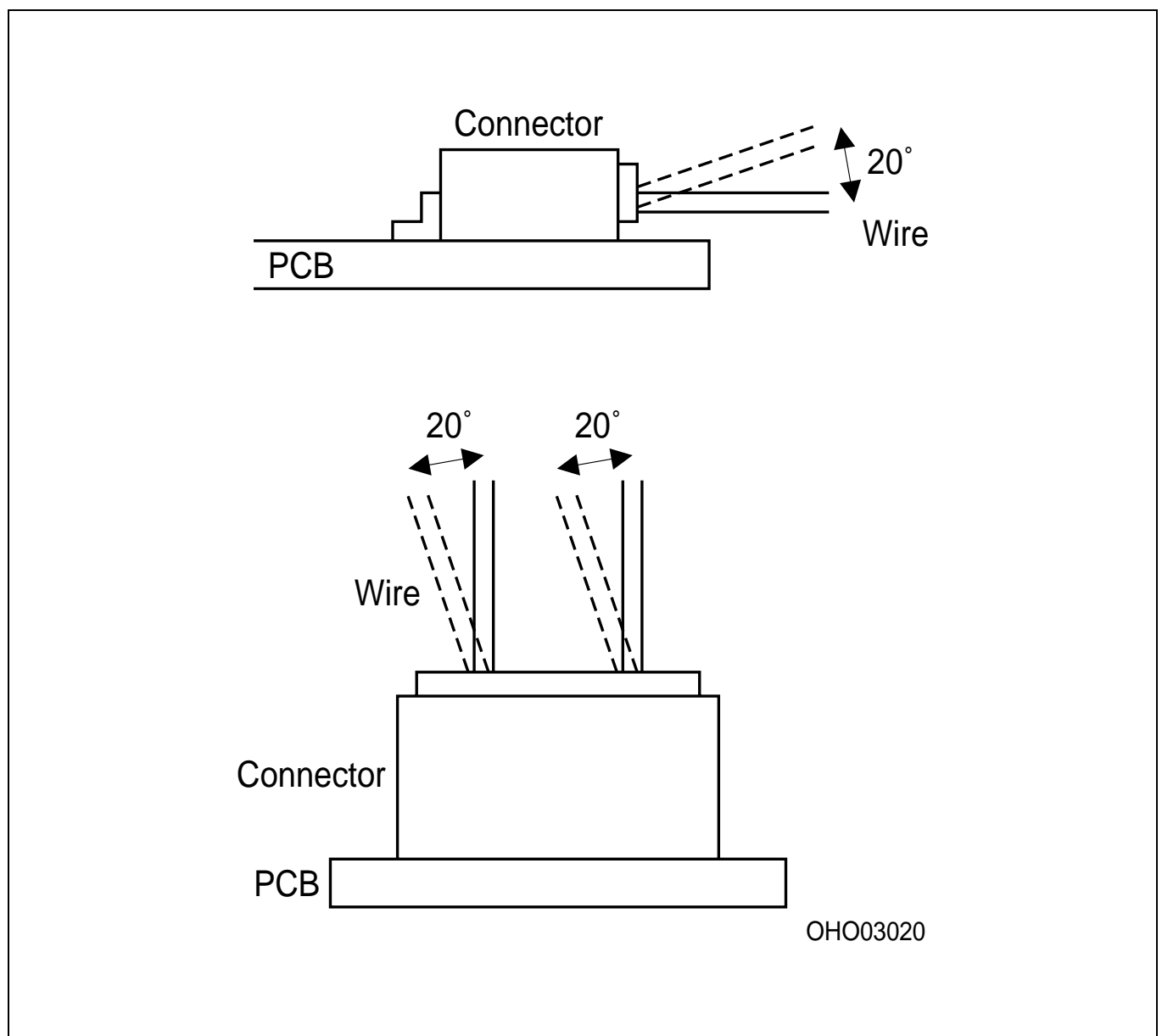

Verpackung ⁹⁾ Seite 17

50 St. pro Box = Verpackungseinheit

Method of Packing ⁹⁾ page 17

50 pcs. per tray = packing unit

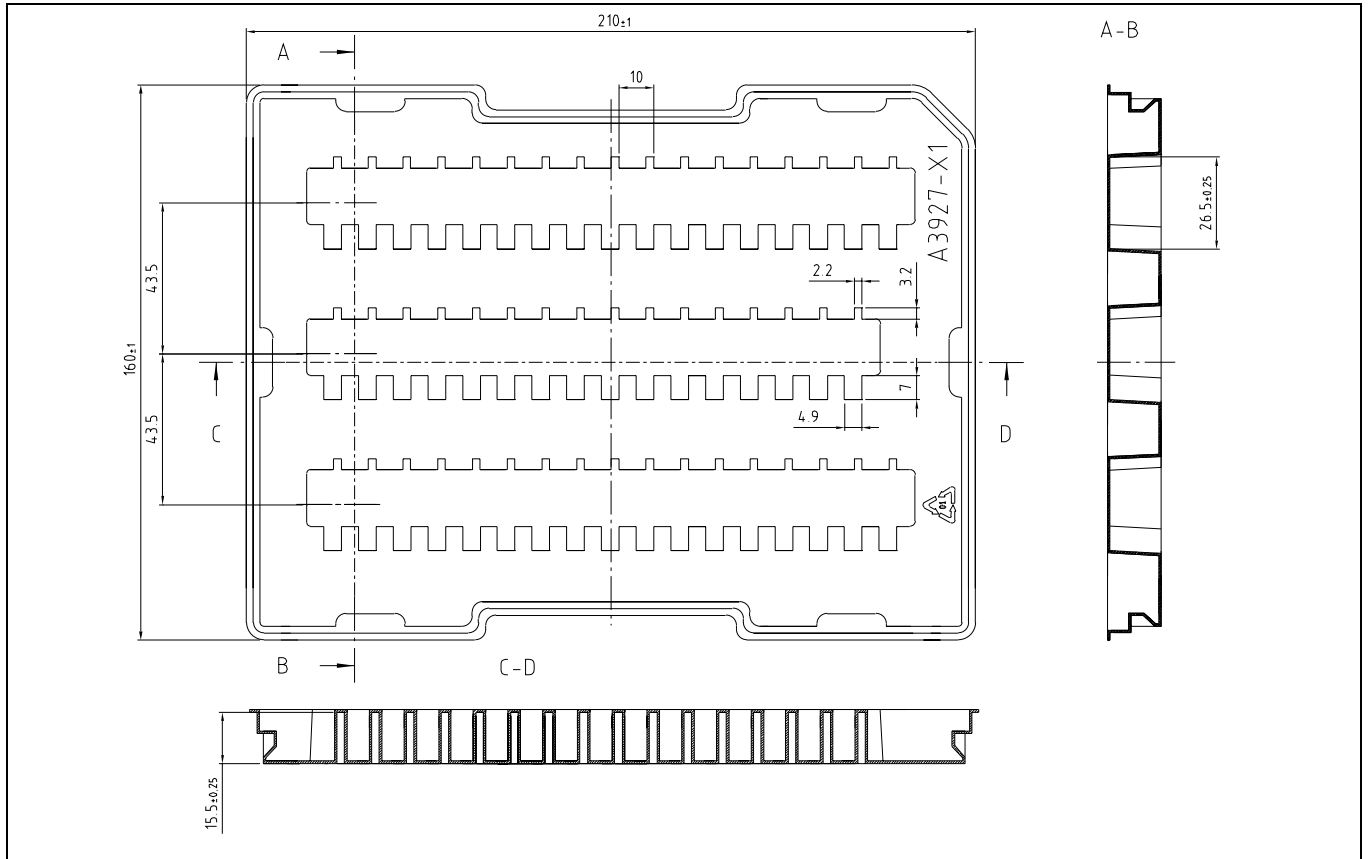

Elektrisches Ersatzschaltbild
Equivalent Circuit Diagram

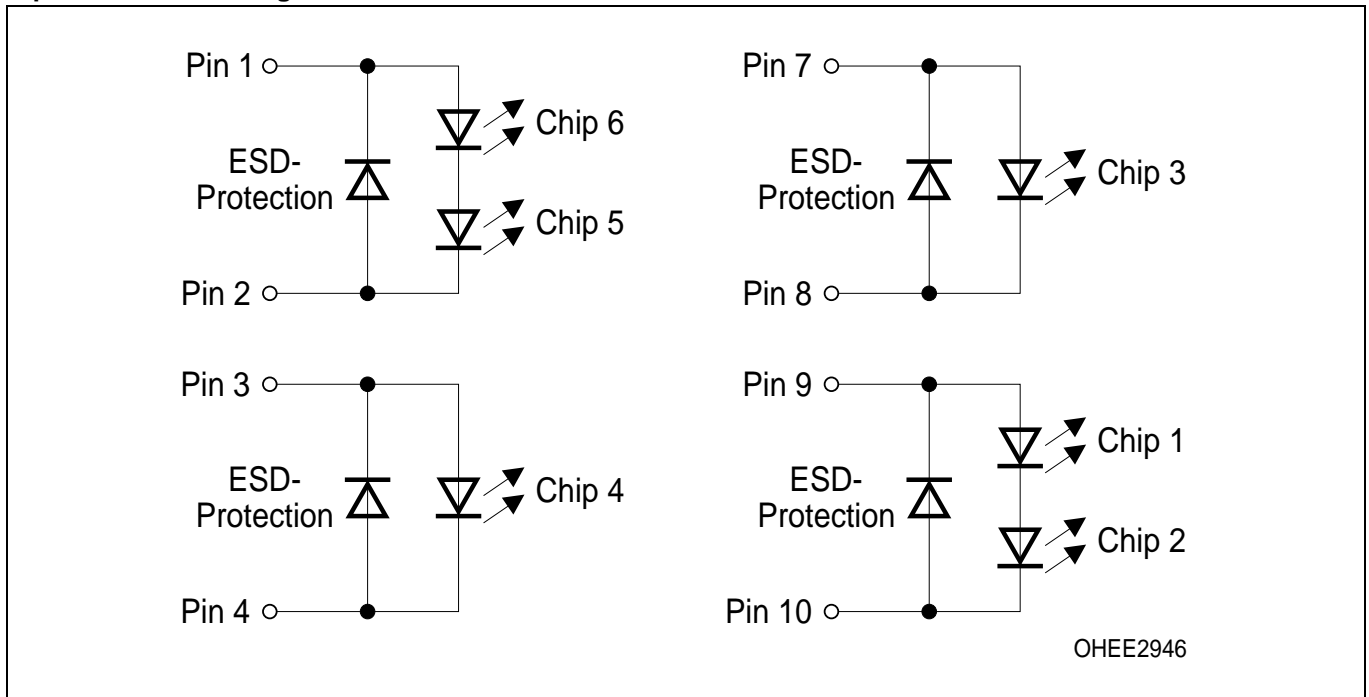

Barcode-Tray-Etikett (BTL)
Barcode-Tray-Label (BTL)

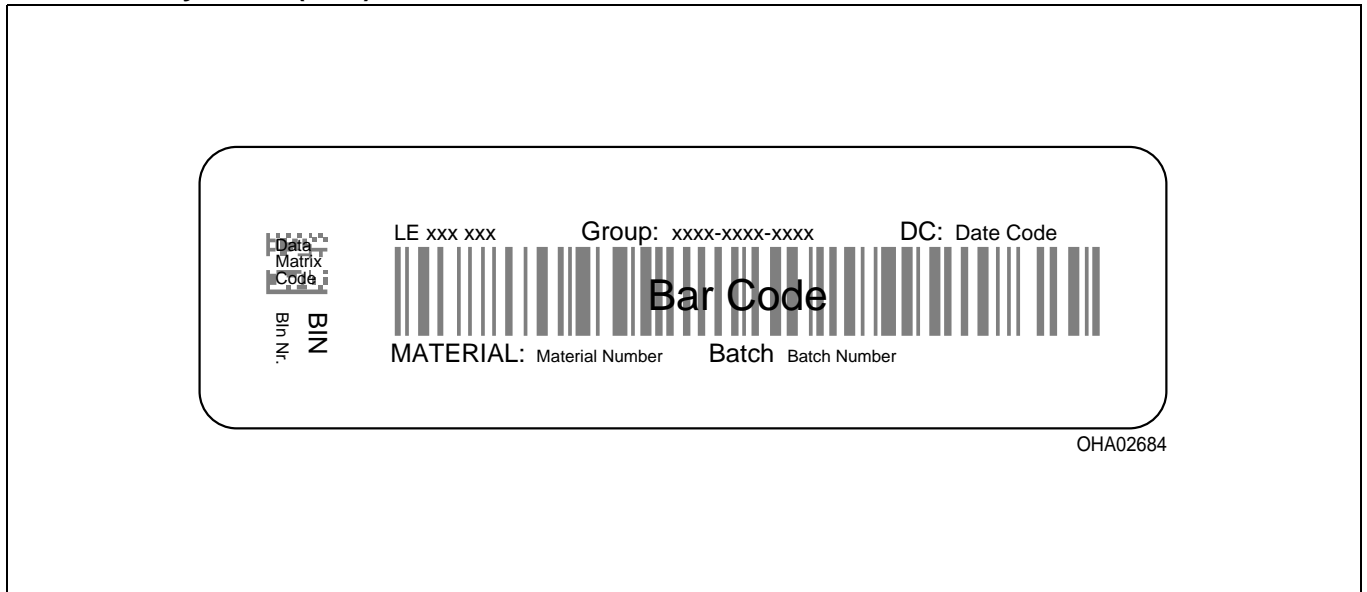

Kartonverpackung und Materialien
Transportation Packing and Materials

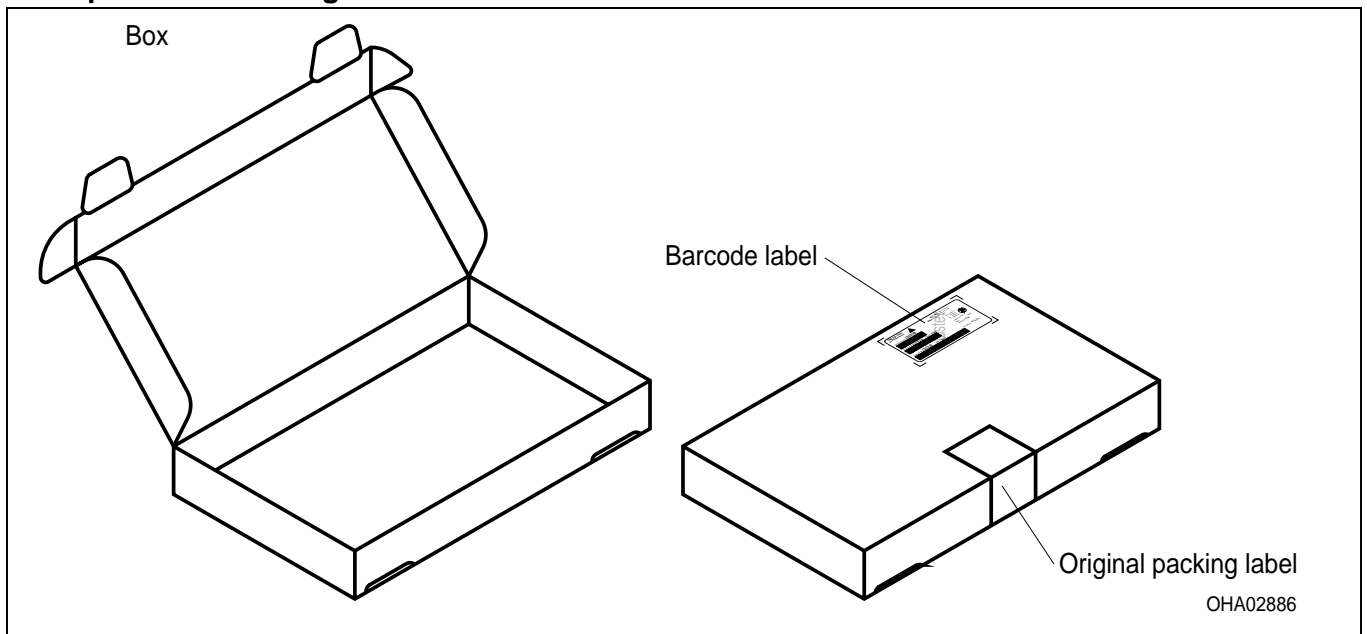

Revision History: 2008-07-07

Previous Version: 2007-01-29

Page	Subjects (major changes since last revision)	Date of change
all	Product Discontinuation OS-PD-2008-008	2008-07-07

Anm.: Gemäß IEC 60825-1 (EN 60825-1) gilt für amber:

Note: According IEC 60825-1 (EN 60825-1) for amber:

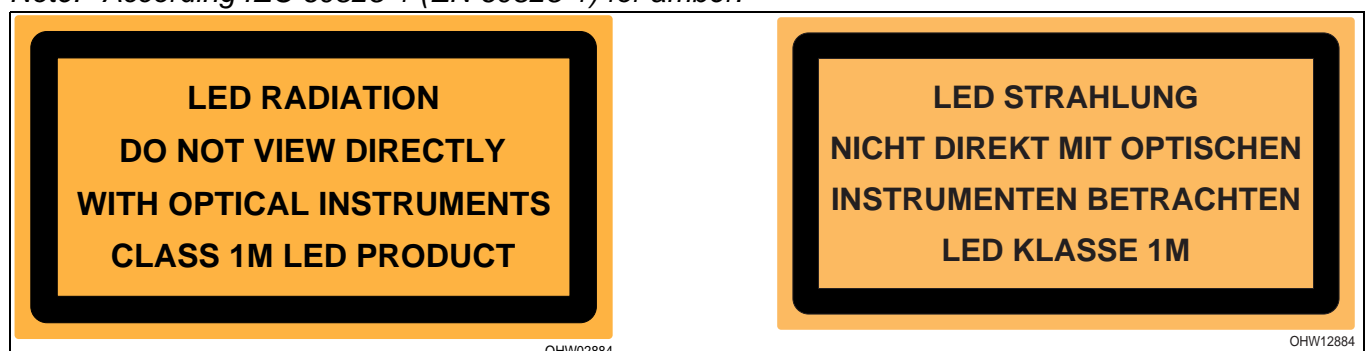

Anm.: Gemäß IEC 60825-1 (EN 60825-1) gilt für blau:

Note: According IEC 60825-1 (EN 60825-1) for blue:

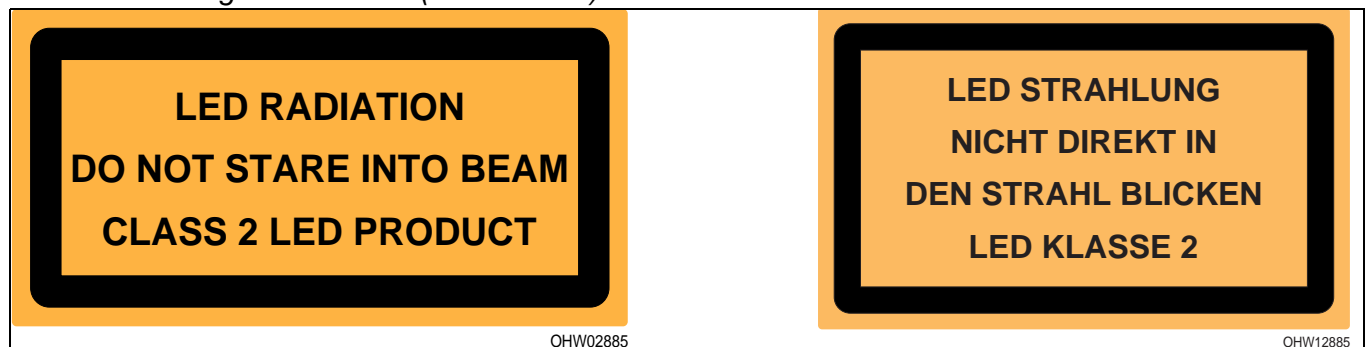
**Attention please!**

The information describes the type of component and shall not be considered as assured characteristics.

Terms of delivery and rights to change design reserved. Due to technical requirements components may contain dangerous substances. For information on the types in question please contact our Sales Organization.

If printed or downloaded, please find the latest version in the Internet.

Packing

Please use the recycling operators known to you. We can also help you – get in touch with your nearest sales office. By agreement we will take packing material back, if it is sorted. You must bear the costs of transport. For packing material that is returned to us unsorted or which we are not obliged to accept, we shall have to invoice you for any costs incurred.

Components used in life-support devices or systems must be expressly authorized for such purpose! Critical components¹⁰⁾ page 17 may only be used in life-support devices or systems¹¹⁾ page 17 with the express written approval of OSRAM OS.

Fußnoten:

- 1) Helligkeitswerte werden mit einer Stromeinprägedauer von 25 ms und einer Genauigkeit von $\pm 11\%$ ermittelt. Messbedingung für Lichtstärkemessung nach CIE127 Condition A.
- 2) Wegen der besonderen Prozessbedingungen bei der Herstellung von LED können typische oder abgeleitete technische Parameter nur aufgrund statistischer Werte wiedergegeben werden. Diese stimmen nicht notwendigerweise mit den Werten jedes einzelnen Produktes überein, dessen Werte sich von typischen und abgeleiteten Werten oder typischen Kennlinien unterscheiden können. Falls erforderlich, z.B. aufgrund technischer Verbesserungen, werden diese typischen Werte ohne weitere Ankündigung geändert.
- 3) Min. Φ_V Werte werden aus den I_V - Werten berechnet. Die Helligkeitswerte auf Seite 2 wurden ohne Primäroptik gemessen.
- 4) Wellenlängen werden mit einer Stromeinprägedauer von 25 ms und einer Genauigkeit von ± 1 nm ermittelt.
- 5) Spannungswerte werden mit einer Stromeinprägedauer von 1 ms und einer Genauigkeit von $\pm 0,1$ V ermittelt.
- 6) Für den Fall, dass eine Optik wie z. B. eine Halbsphärenlinse als Primäroptik verwendet wird, kann der Lichtfluss bis zu 40% für rot und grün und 36% für blau erhöht werden.
- 7) Die R-T-Kurve eines NTC läßt sich in einem engen Bereich um den spezifizierten Wert herum in erster Näherung durch einen exponentialen Zusammenhang beschreiben. Sofern eine detailliertere Beschreibung der R-T-Kurve für die Praxis nötig ist, können eine genauere Formel und entsprechende tabellierte Werte bei EPCOS gefunden werden.
- 8) Im gestrichelten Bereich der Kennlinien muss mit erhöhten Helligkeitsunterschieden zwischen Leuchtdioden innerhalb einer Verpackungseinheit gerechnet werden.
- 9) Maße werden wie folgt angegeben: mm (inch).
- 10) Ein kritisches Bauteil ist ein Bauteil, das in lebenserhaltenden Apparaten oder Systemen eingesetzt wird und dessen Defekt voraussichtlich zu einer Fehlfunktion dieses lebenserhaltenden Apparates oder Systems führen wird oder die Sicherheit oder Effektivität dieses Apparates oder Systems beeinträchtigt.
- 11) Lebenserhaltende Apparate oder Systeme sind für (a) die Implantierung in den menschlichen Körper oder (b) für die Lebenserhaltung bestimmt. Falls sie versagen, kann davon ausgegangen werden, dass die Gesundheit und das Leben des Patienten in Gefahr ist.

Published by
OSRAM Opto Semiconductors GmbH
 Leibnizstrasse 4, D-93055 Regensburg
www.osram-os.com
 © All Rights Reserved.

Remarks:

- 1) Brightness groups are tested at a current pulse duration of 25 ms and a tolerance of $\pm 11\%$. Condition for luminous intensity measurement acc. to CIE127 condition A
- 2) Due to the special conditions of the manufacturing processes of LED, the typical data or calculated correlations of technical parameters can only reflect statistical figures. These do not necessarily correspond to the actual parameters of each single product, which could differ from the typical data and calculated correlations or the typical characteristic line. If requested, e.g. because of technical improvements, these typ. data will be changed without any further notice.
- 3) Min. Φ_V values are calculated from I_V values. Brightness values stated on page 2 are measured without primary optics.
- 4) Wavelengths are tested at a current pulse duration of 25 ms and a tolerance of ± 1 nm.
- 5) Forward voltages are tested at a current pulse duration of 1 ms and a tolerance of ± 0.1 V.
- 6) If an optic, such as a hemispherical lens is added, the luminous flux values can be increased up to 40% for red and green and 36% for blue.
- 7) The R-T-Curve of an NTC thermistor can be roughly described in a restricted range around the rated temperature. If a more precise description of the R/T curve is required for practical applications a refined formula and the corresponding tabulated values can be found at EPCOS
- 8) In the range where the line of the graph is broken, you must expect higher brightness differences between single LEDs within one packing unit.
- 9) Dimensions are specified as follows: mm (inch).
- 10) A critical component is a component used in a life-support device or system whose failure can reasonably be expected to cause the failure of that life-support device or system, or to affect its safety or the effectiveness of that device or system.
- 11) Life support devices or systems are intended (a) to be implanted in the human body, or (b) to support and/or maintain and sustain human life. If they fail, it is reasonable to assume that the health and the life of the user may be endangered.

EU RoHS and China RoHS compliant product



此产品符合欧盟 RoHS 指令的要求；

按照中国的相关法规和标准，不含有毒有害物质或元素。